

Mayo

AG & INDUSTRIAL PARTS CATALOG

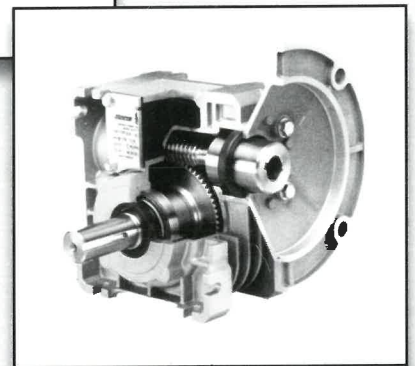
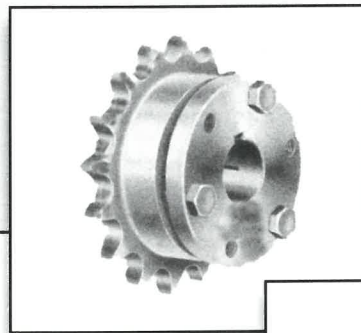

MAYO MFG. INC.

Mayo

MANUFACTURING COMPANY

WWW.MAYOMFG.COM

PH: 1.800.223.5873 FAX: 218.773.0995

WELCOME TO

Mayo

Mayo Manufacturing Company offers a unique blend of products and services for agricultural customers.

Our parts supply division carries a large inventory of power transmission components for potato, sugar beet, grain and bean producers as well as industrial users and processors.

Our manufacturing division provides belt conveyors and custom design services for the handling of edible beans and other commodities. In addition, Mayo provides a range of potato handling equipment.

All of our products are the highest quality available.

SAFETY

Your safety is important to us. Read the safety manuals. Make sure that all equipment is disengaged when servicing and assure that shields are in place.

For electric equipment, have an electrician regularly inspect and provide service to ensure safe operation.

Contact Mayo at any time that we can be of assistance in providing safety manuals, shields and advice.

INDEX

Idlers & Sprockets	4-7
Bushings	8
Chain Links	9-10
Weld A Hub & Sprockets	10-11
Key Shaft & Couplers	12
Acme Rods & Threaded Rods	12
Sheaves	13-14
V-Belts	15
Electric Motors	16-17
Browning Speed Reducers	17-18
Winsmith Speed Reducers	19
Winsmith Hollow Shaft Reducers	20
Bearings & Inserts	21-23
Bean Equipment Parts	24-29
Potato Equipment	30-31
Hydraulic Components	32-34
Couplings	35
Orbit Motors	36
Belt Lace	37
Trailer Components	38-39
Wheels	40
Belting	41
Flexco Fasteners	42-43
Conveyor Components	44-45
Sugar Beet Components	46-47
Roller Components	48
Conveyor Chains	49
Lubricants & Paint	50
Electrical Components	51

SPROCKETS

Browning

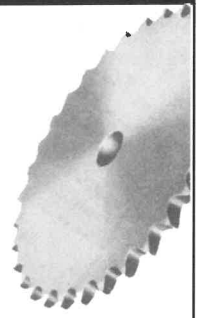

TYPE "A" STEEL PLATE SPROCKETS

• Black Oxide Finish • Call for Other Sizes • Call for Quotes

IDLER SPROCKET

ITEM NO.	SIZE	BORE
1233300	4017	5/8
1233400	5013	5/8
1233500	5017	5/8
1233700	5017	1/2
1233600	5017	5/8
1233900	6011	1/2
1234000	6011	5/8
1234100	6013	1/2
1234300	6013	5/8
1234150	8012	5/8
1235000	HB80A12	3/4

ITEM NO.	SIZE	BORE	ITEM NO.	SIZE	BORE	ITEM NO.	SIZE	BORE
1001600	40A16	5/8	1009550	60A41	5/8	1031800	H4018	3/4
1001700	40A20	5/8	1010200	60A48	5/8	1032100	H4018	1
1001800	40A22	5/8	1010600	60A60	3/4	1032300	H4018	1 1/4
1001900	40A24	5/8	1010700	60A64	3/4	1032400	H4019	3/4
1002100	40A26	5/8	1011100	80A11	3/4	1032500	H4019	1
1002200	40A30	5/8	1011300	80A12	3/4	1032600	H4019	1 1/4
1002210	40A31	5/8	1011500	80A14	3/4	1032700	H4020	3/4
1002400	40A35	5/8	1011700	80A16	3/4	1032800	H4020	7/8
1002500	40A40	5/8	1011900	80A18	3/4	1032900	H4020	1
1003900	50A18	5/8	1012100	80A20	3/4	1033100	H4021	1
1004400	50A23	3/4	1012500	80A24	3/4	1033105	H4016	1 1/8
1004600	50A24	3/4	1012600	80A25	3/4	1031300	H4017	3/4
1004800	50A26	3/4	1012800	80A28	1	1031400	H4017	7/8
1004900	50A27	3/4	1013100	80A34	1	1031500	H4017	1
1005100	50A30	3/4	1013300	80A36	1	1031700	H4018	5/8
1005300	50A32	3/4	1014200	80A65	1	1031800	H4018	3/4
1005600	50A36	3/4	1026900	H3514	3/4	1032100	H4018	1
1005800	50A38	3/4	1028000	H4010	5/8	1032300	H4018	1 1/4
1006000	50A40	3/4	1028100	H4010	3/4	1032400	H4019	3/4
1006400	50A47	5/8	1028300	H4011	5/8	1032500	H4019	1
1006500	50A48	5/8	1028400	H4011	3/4	1032600	H4019	1 1/4
1006600	50A50	5/8	1028500	H4011	7/8	1032700	H4020	3/4
1006700	50A54	5/8	1028600	H4012	5/8	1032700	H4020	7/8
1006750	50A60	5/8	1028800	H4012	3/4	1032800	H4020	7/8
1006900	50A96	5/8	1028900	H4012	7/8	1032900	H4020	1
1007200	60A13	5/8	1029000	H4012	1	1033100	H4021	1
1007300	60A14	5/8	1029100	H4013	1/2	1033400	H4022	3/4
1007400	60A15	5/8	1029200	H4013	5/8	1034200	H4024	1
1007600	60A17	5/8	1029300	H4013	3/4	1034400	H4024	1 1/4
1007800	60A18	5/8	1029500	H4013	1	1034600	H4026	1
1007900	60A19	5/8	1029600	H4014	5/8	1034800	H4027	1
1008000	60A20	5/8	1029700	H4014	3/4	1034900	H4028	1
1008100	60A21	5/8	1029750	H4014	3/4	1035010	H4023	1 3/16
1008400	60A24	5/8	1029900	H4014	7/8	1035200	4040	1
1008500	60A25	5/8	1030000	H4014	1	1035400	4045	1
1008700	60A27	5/8	1030300	H4015	7/8	1035600	H509	3/4
1008800	60A28	5/8	1030400	H4015	1	1035800	H5010	3/4
1008900	60A29	5/8	1030900	H4016	7/8			
1009000	60A30	5/8	1031000	H4016	1			
1009100	60A32	5/8	1031050	H4016	1/8			
1009200	60A35	5/8	1031300	H4017	3/4			
1009300	60A36	5/8	1031400	H4017	7/8			
1009400	60A38	5/8	1031500	H4017	1			
1009500	60A40	5/8	1031700	H4018	5/8			

SNAP IDLES



- UHMW
- Self Lubricating
- Long Life

ITEM NO.	PART NO.	CHAIN SIZE
1463700	SI-40	40
1463800	SI-50	50
1463900	SI-60	60
1464000	SI-80	80

Mayo

Ph: 1.800.223.5873 • Fax: 218.773.0995 • www.mayomfg.com

MasterCard • Visa

SPROCKETS

Browning

- Black Oxide Finish
- Standard Keyway
- Available in Hardened
- Call for Sizes and Quotes

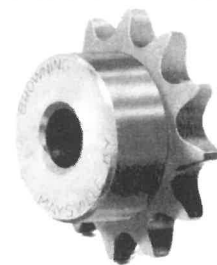

FINISHED BORE SPROCKETS

ITEM NO.	SIZE	BORE
1035900	H5010	7/8
1036000	H5010	1
1036200	H5011	3/4
1036400	H5011	1
1036500	H5011	1 1/8
1036650	H5012	5/8
1036700	H5012	3/4
1036800	H5012	7/8
1036900	H5012	1
1037000	H5012	1 1/8
1037200	H5012	1 1/4
1037300	H5013	5/8
1037400	H5013	3/4
1037500	H5013	7/8
1037600	H5013	1
1037650	H5013	1
1037700	H5013	1 1/8
1037900	H5013	1 1/4
1038200	H5014	3/4
1038400	H5014	7/8
1038500	H5014	1
1038600	H5014	1 1/8
1038700	H5014	1 3/16
1038800	H5014	1 1/4
1039100	H5015	3/4
1039200	H5015	7/8
1039300	H5015	1
1039400	H5015	1 1/8
1039500	H5015	1 3/16
1039600	H5015	1 1/4
1039700	H5015	1 3/8
1039800	H5015	1 7/16
1039975	H5016	3/4
1040000	H5016	7/8
1040200	H5016	1
1040300	H5016	1 7/16
1040400	H5016	1 1/8
1040600	H5016	1 1/4
1040800	H5016	1 3/8
1041100	H5017	1 1/4
1041300	H5017	1
1041400	H5017	1 1/8
1041500	H5017	1 1/4
1041900	H5018	3/4
1042000	H5018	7/8
1042100	H5018	1
1042200	H5018	1 1/8
1042300	H5018	1 3/16
1042400	H5018	1 7/16
1043000	H5019	1 1/4
1043200	H5020	3/4

ITEM NO.	SIZE	BORE
1043300	H5020	7/8
1043400	H5020	1
1043500	H5020	1 1/8
1043700	H5020	1 1/4
1043900	H5020	1 7/16
1044000	H5021	1
1044100	H5021	1 1/8
1044200	H5021	1 1/4
1042500	H6027	1
1044400	H5022	1
1044600	H5022	1 1/4
1044800	H5023	7/8
1044900	H5023	1
1045000	H5023	1 1/4
1045300	H5024	7/8
1045400	H5024	1
1045600	H5024	1 1/4
1045700	H5024	1 3/8
1045800	H5024	1 7/16
1045900	H5025	1
1046000	H5025	1/4
1046100	H5026	1
1046200	H5026	1 1/4
1046400	H5027	1
1046600	H5028	1
1046700	H5028	1 1/4
1046900	H5030	1
1047000	H5030	1 1/4
1047150	H5030	1 7/16
1047400	5032	1
1047500	5035	1
1047900	5036	1
1048000	5036	1 1/4
1048100	5040	1
1048200	5040	1 1/4
1048300	5048	1
1048500	H609	3/4
1048900	H6010	1
1048950	H6010	1
1049100	H6010	1 1/4
1049400	H6011	1
1049700	H6011	1 1/4
1049900	H6012	7/8
1049500	H6012	7/8

ITEM NO.	SIZE	BORE
1050000	H6012	1
1050100	H6012	1 1/8
1050200	H6012	1 1/4
1050300	H6012	1 3/8
1050400	H6012	1 7/16
1050600	H6013	1
1050700	H6013	1 1/8
1050800	H6013	1 1/4
1051000	H6013	1 3/8
1051100	H6013	1 7/16
1051250	H6014	7/8
1051300	H6014	1
1051400	H6014	1 1/8
1051500	H6014	1 1/4
1051600	H6014	1 3/8
1051700	H6014	1 7/16
1051800	H6014	1 1/2
1052000	H6015	7/8
1052100	H6015	1
1052200	H6015	1 1/8
1052300	H6015	1 3/16
1052400	H6015	1 7/16
1052500	H6015	1 3/8
1052600	H6015	1 1/2
1052700	H6015	1 1/4
1052800	H6016	1
1052900	H6016	1 1/8
1053000	H6016	1 3/16
1053100	H6016	1 1/4
1053200	H6016	1 3/8
1053400	H6016	1 7/16
1053500	H6016	1 1/2
1053600	H6016	1 3/4
1053700	H6017	1
1053800	H6017	1 1/4
1053900	H6017	1 1/8
1054400	H6017	1 3/8
1054500	H6017	1 7/16
1054700	H6018	1
1054800	H6018	1 1/8
1054900	H6018	1 1/4
1055000	H6018	1 3/8
1055200	H6018	1 7/16
1054400	H6017	1 3/8

Ph: 1.800.223.5873 • Fax: 218.773.0995 • www.mayomfg.com

MasterCard • Visa

Mayo

SPROCKETS

ITEM NO.	SIZE	BORE
1054500	H6017	1 7/16
1054700	H6018	1
1054800	H6018	1 1/8
1054900	H6018	1 1/4
1055000	H6018	1 3/8
1055200	H6018	1 7/16
1055900	H6019	1
1056000	H6019	1 1/8
1056100	H6019	1 1/4
1056200	H6019	1 3/8
1056250	H6019	1 7/16
1056300	H6019	1 1/2
1056700	H6019	1
1056800	H6019	1 1/8
1056900	H6019	1 3/8
1057000	H6020	1 1/4
1057300	H6020	1 1/2
1057400	H6020	1 7/16
1057600	H6020	1 3/4
1057700	H6021	1
1057900	H6021	1 1/8
1058000	H6021	1 1/4
1058050	H6021	1 3/8
1058100	H6021	1 7/16
1058110	H6015	1 3/4
1052710	H6021	1 3/4
1058300	H6022	1
1058400	H6022	1 1/8
1058500	H6022	1 1/4
1058700	H6022	1 7/16
1059000	H6022	1 3/4
1059100	H6023	1
1059200	H6023	1 1/4
1059500	H6024	1
1059600	H6024	1 1/8
1059800	H6024	1 1/4
1059900	H6024	1 3/8
1060000	H6024	1 1/2
1060050	H6024	1 3/4
1060100	H6025	1
1060200	H6025	1 1/8
1060300	H6025	1 1/4
1061200	H6025	1 1/2
1060600	H6025	1 3/8
1060700	H6025	1 7/16
1060800	H6025	1 3/4
1061000	H6026	1 1/8
1061400	H6026	1 1/4
1061700	H6026	1 7/16
1042500	H6027	1
1061800	H6028	1

ITEM NO.	SIZE	BORE
1061900	H6028	1 3/8
1062400	H6028	1 7/16
1062100	H6029	1
1062200	H6030	1
1062700	H6030	1 1/4
1062800	H6030	1 7/16
1062900	H6030	1 3/4
1063200	6035	1 1/4
1063300	6036	1
1063400	6036	1 1/8
1063500	6036	1 1/4
1064000	H809	1
1064100	H809	1 1/4
1064400	H8011	1 1/4
1064500	H8012	1
1064600	H8012	1 3/8
1064800	H8012	1 1/4
1064900	H8012	1 3/4
1065100	H8013	1 1/8
1065200	H8014	1 3/8
1065300	H8014	1 1/4
1065400	H8014	1 3/4
1065450	H8014	2
1065750	H8015	1 3/8
1065800	H8016	1 1/4
1066000	H8016	1 3/8
1066100	H8016	1 7/16
1066200	H8016	1 3/4
1066350	H8016	2
1066500	H8018	1 1/4
1066600	H8018	1 3/8
1066900	H8018	1 3/4
1067000	H8020	1 1/4
1067225	H8021	2
1067500	H8024	1 7/16
1067550	H8024	2
1068000	H8025	1 1/4

TYPE "B" MINIMUM BORE SPROCKETS

• Black Oxide Finish

Browning



ITEM NO.	SIZE	BORE
1015100	25B15	1/4
1015125	35B13	1/2
1015200	35B11	3/8
1000400	35B25	1/2
1015300	35B36	5/8
1016100	40B23	5/8
1016500	40B38	5/8
1017000	50B9	5/8
1017300	50B12	5/8
1017900	50B13	5/8
1018200	50B16	5/8
1018300	50B17	5/8
1018400	50B18	5/8
1019000	50B25	3/4
1020500	60B12	3/4
1020800	60B14	3/4
1020900	60B15	3/4
1021000	60B16	3/4
1021100	60B17	3/4
1021200	60B18	3/4
1021700	60B22	3/4
1021900	60B24	3/4
1022100	60B26	3/4
1022300	60B30	3/4
1022400	60B32	3/4
1022600	60B34	3/4
1023000	60B40	3/4
1023050	60B42	3/4
1023500	80B9	3/4
1023600	80B10	3/4
1023700	80B11	3/4
1023800	80B12	3/4
1024100	80B15	3/4
1024300	80B17	3/4
1024800	80B21	3/4
1024900	80B22	3/4
1025000	80B23	3/4
1025100	80B24	3/4

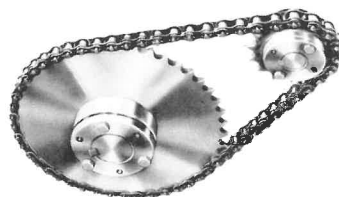

WORLD-CLASS

**Call for Other
Sizes & Quotes!**

Mayo

Ph: 1.800.223.5873 • Fax: 218.773.0995 • www.mayomfg.com

MasterCard • Visa

SPROCKETS

Browning



- Black Oxide Finish
- H Denotes Hardened
- All Available Hardened

**Call for Sizes
and Quotes**

ITEM NO.	SIZE	BUSH. REQ.	ITEM NO.	SIZE	BUSH. REQ.	ITEM NO.	SIZE	BUSH. REQ.	ITEM NO.	SIZE	BUSH. REQ.
1076200	40P34	P1	1076400	H40H35	H	1084700	H60H20	H	1095000	H80Q25	Q1
1076500	40P36	P1	1074000	H40P18	P1	1093770	H60H22	H	1095100	H80Q26	Q1
1076600	40P38	P1	1074200	H40P19	P1	1093780	H60H24	H	1095300	H80Q27	Q1
1076700	40P40	P1	1074600	H40P21	P1	1083400	H60P13	P1	1095500	H80Q30	Q1
1077200	40P60	P1	1074700	H40P22	P1	1083600	H60P14	P1	1099700	H100Q16	Q1
1081300	50P35	P1	1074900	H40P23	P1	1083800	H60P15	P1	1099900	H100Q17	Q1
1081400	50P36	P1	1075200	H40P24	P1	1084100	H60P16	P1	1100200	H100Q20	Q1
1081700	50Q30	Q1	1075300	H40P25	P1	1084200	H60P17	P1			
1081900	50Q42	Q1	1075500	H40P26	P1	1084400	H60P18	P1			
1082050	50Q45	Q1	1075800	H40P28	P1	1084600	H60P19	P1			
1082200	50Q48	Q1	1076000	H40P30	P1	1084800	H60P20	P1			
1082500	50Q60	Q1	1077500	H50H13	H	1085000	H60P21	P1			
1087400	60Q36	Q1	1077700	H50H14	H	1085200	H60P22	P1			
1087500	60Q37	Q1	1077800	H50H15	H	1085400	H60P23	P1			
1087600	60Q38	Q1	1078000	H50H16	H	1085600	H60P24	P1			
1087800	60Q40	Q1	1078300	H50H17	H	1085800	H60P25	P1			
1087910	60Q41	Q1	1078400	H50H18	H	1086200	H60P27	P1			
1088000	60Q42	Q1	1078700	H50H19	H	1086400	H60P28	P1			
1088500	60Q44	Q1	1078800	H50H20	H	1086700	H60P29	P1			
1088700	60Q45	Q1	1079000	H50H21	H	1084900	H60P30	Q1			
1088900	60Q48	Q1	1079200	H50H22	H	1085100	H60Q21	Q1			
1089100	60Q50	Q1	1079300	H50H23	H	1085300	H60Q22	Q1			
1089300	60Q54	Q1	1079600	H50H24	H	1085700	H60Q24	Q1			
1089500	60Q60	Q1	1079900	H50H25	H	1085900	H60Q25	Q1			
1089800	60Q72	Q1	1080700	H50H30	H	1086100	H60Q26	Q1			
1095700	80Q32	Q1	1080000	H50H35	H	1086300	H60Q27	Q1			
1095900	80Q34	Q1	1077900	H50H15	P1	1086500	H60Q28	Q1			
1096000	80Q35	Q1	1078100	H50H16	P1	1089100	H60Q50	Q1			
1096100	80Q36	Q1	1078200	H50H17	P1	1089300	H60Q54	Q1			
1096300	80Q38	Q1	1078500	H50H18	P1	1092500	H80P12	P1			
1096400	80Q40	Q1	1078600	H50P19	P1	1092700	H80P13	P1			
1096600	80Q45	Q1	1078900	H50P21	P1	1092800	H80P14	P1			
1097000	80Q60	Q1	1079300	H50P22	P1	1093300	H80P15	P1			
1096800	80R48	R1	1079500	H50P23	P1	1094300	H80P19	P1			
1073600	H40H15	H	1079800	H50P24	P1	1093100	H80Q14	Q1			
1073700	H40H16	H	1080500	H50P28	P1	1093400	H80Q15	Q1			
1073900	H40H18	H	1080800	H50P30	P1	1093600	H80Q16	Q1			
1074300	H40H20	H	1079700	H50Q24	Q1	1093800	H80Q17	Q1			
1074800	H40H23	H	1082800	H60H11	H	1094000	H80Q18	Q1			
1075600	H40H26	H	1083200	H60H12	H	1094400	H80Q19	Q1			
1075400	H40H28	H	1083300	H60H13	H	1094500	H80Q20	Q1			
1075900	H40H30	H	1083900	H60H16	H	1094700	H80Q22	Q1			



DOUBLE & DOUBLE SINGLE SPROCKETS

TAPER LOCK BUSH TYPE

- Type "A" Minimum Bore
- Type "B" Minimum Bore

1073110	D50B12	5/8
1077600	D50B13	5/8
1082900	D50B17	3/4
1083000	D50PP1	7 1/2-1 3/4
1083100	D50PP2	1 1/2-1 3/4
1073100	D50Q36	3/4 2 11/16
1090000	D60B13	1
1090200	D60B15	1
1090300	D60B18	1
1090500	D60B24	1
1091700	D60P18	1 1/2-1 3/4
1090800	D60P20	1 1/2-1 3/4
1088100	D60Q42	3/4-2 1/16

Ph: 1.800.223.5873 • Fax: 218.773.0995 • www.mayomfg.com

MasterCard • Visa

Mayo

BUSHINGS

Browning

*Choice of three bushings —
Split Taper, QD*, Taper Bore*

SPLIT TAPER BUSHINGS

ITEM NO.	SIZE	BORE
1105010	H	1 3/8-3/8
1105100	H	7/16
1105300	H	9/16
1105400	H	5/8
1106100	H	11/16
1105600	H	3/4
1105700	H	13/16
1105800	H	7/8
1105900	H	15/16
1106000	H	1
1106050	H	1 1/16
1106200	H	1 1/8
1106400	H	1 3/16
1106500	H	1 1/4
1106700	H	1 3/8-5/16
1107250	H	1 5/16
1107100	H	1 7/16
1107200	H	1 1/2

ITEM NO.	SIZE	BORE
1108000	P1	1/2
1108100	P1	5/8
1108200	P1	3/4
1108300	P1	7/8
1108400	P1	15/16
1108500	P1	1
1108700	P1	1 1/8
1108800	P1	1 3/16
1108900	P1	1 1/4
1109200	P1	3/8
1109300	P1	1 3/8 15/16
1109350	P1	1 3/8-3/8
1109700	P1	1 7/16
1109800	P1	1 1/2
1109900	P1	1 9/16
1110000	P1	1 5/8
1110200	P1	1 3/4
1110500	P2	1 1/8
1110900	P2	1 3/8-5/16
1111000	P2	1 3/8-3/8
1111300	P2	1 5/8

ITEM NO.	SIZE	BORE
1112000	Q1	15/16
1112200	Q1	1
1112300	Q1	1 1/8
1112400	Q1	1 3/16
1112600	Q1	1 1/4
1112700	Q1	1 3/8-5/16
1112800	Q1	1 3/8-3/8
1113100	Q1	1 7/16
1113200	Q1	1 1/2
1113400	Q1	1 5/8
1113500	Q1	1 11/16
1113600	Q1	1 3/4
1113800	Q1	1 7/8
1113900	Q1	1 15/16
1114000	Q1	2
1114100	Q1	2 1/8
1114200	Q1	2 3/16
1114300	Q1	2 1/4
1114400	Q1	2 3/8
1114500	Q1	2 7/16
1114700	Q1	2 1/2
1114900	Q1	2 5/8
1115800	Q2	1 7/8
1116000	Q2	1 15/16
1115900	Q2	2
1116100	Q2	2/18
1116200	Q2	2 1/4



**Other Sizes
Available!**

**QD SIZES AVAILABLE
CALL FOR
MORE INFORMATION!**



CHAIN LINKS

SPROCKETS

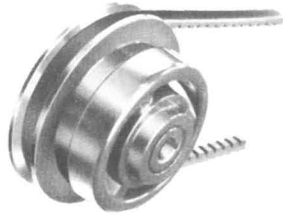

VARIABLE SPEED PULLEYS

ITEM NO.	PART NO.	BORE
1204700	40TBR	3/4
1204600	40TBR	5/8
1204900	50TBR	3/4
1204800	50TBR	5/8
1205000	50TBR	7/8
1205200	57-20TBR	3/4
1205100	57-20TBR	5/8
1205300	57-20TBR	7/8
1205500	57TBR	3/4
1205400	57TBR	5/8
1205600	57TBR	7/8
1205700	57TBR	1
1205800	57TBR	1 1/8
1206000	66TBR	3/4
1205900	66TBR	7/8
1206100	66TBR	1
1206200	66TBR	1 1/8
1206300	86TBR	3/4
1306400	86TBR	7/8
1206500	86YBR	1
1206600	86TBR	1 1/8



**BROWNING & THERMOID
VARIABLE SPEED BELTS
CALL FOR SIZES & QUOTES**



**ER CHAIN
AMERICAN MADE
CALL FOR SPECIAL SIZES**

SINGLE STRAND



- ANSI Rated
- American Made
- Available Imported

ITEM NO.	SIZE	PITCH	LENGTH
1320600	#35	3/8	10'
1320705	#40	1/2	10'
1320700	#40	1/2	50'
1321105	#50	5/8	10'
1321100	#50	5/8	50'
1321605	#60	3/4	10'
1321600	#60	3/4	50'
1321905	#80	1	10'
1321900	#80	1	50'
1322200	#100	1 1/4	10'
1323000	#120	1 1/2	10'
1323100	#140	1 3/4	10'
1323300	#160	2	10'

SINGLE STRAND

HEAVY

- ANSI Rated
- American Made
- Available Imported



ITEM NO.	SIZE	PITCH	LENGTH
1321615	#60H	3/4	10'
1321610	#60H	3/4	50'
1322005	#80H	1	10'
1322000	#80H	1	50'

EXTENDED

PITCH

- ANSI Rated
- American Made
- Available Imported



ITEM NO.	SIZE	PITCH	LENGTH
1323605	#2040	1/2	10'
1323600	#2040	1/2	50'
1323405	#2050	5/8	10'
1323400	#2050	5/8	50'

DOUBLE STRAND

- ANSI Rated
- American Made



ITEM NO.	SIZE	PITCH	LENGTH
1321405	#50-2	5/8	10'
1321400	#50-2	5/8	50'
1322400	#60-2	3/4	10'

EXTENDED PITCH

WITH PIN ATTACHED



ITEM NO.	SIZE	PITCH	LENGTH
1329900	#2060	1/2	10'
1329800	#2060	9/16	10'

Ph: 1.800.223.5873 • Fax: 218.773.0995 • www.mayomfg.com

MasterCard • Visa

Mayo

CHAIN LINKS

WELD A HUB & SPROCKETS

CONNECTOR LINKS

American Made
Any Quantity
Available



ITEM NO.	SIZE	BORE
1331700	25	1/4
1331800	35	3/8
1331900	40	1/2
1334100	40-2	1/2
1335000	2040	1
1332100	41	1/2
1332200	42	1/2
1332300	50	5/8
1334050	50-2	5/8
1335100	2050	1 1/4
1332500	60	3/4
1334300	60-2	3/4
1334500	60-3	3/4
1332800	60H	3/4
1334600	60H-2	3/4
1335300	2060	1 1/2
1339875	2060H	1 1/2
1333000	80	1
1334700	80-2	1
1334800	80-3	1
1333400	80H	1
1333500	100	1 1/4
1334900	100-2	1 1/4
1333700	120	1 1/2
1333800	140	1 3/4
1333900	160	2

OFFSET LINKS

American Made
Any Quantity
Available



ITEM NO.	SIZE	BORE
1336400	25	1/4
1331800	35	3/8
1334000	35-2	3/8
1336600	40	1/2
1338900	40-2	1/2
1339500	2040	1
1336800	41	1/2
1336900	42	1/2
1337000	50	5/8
1339000	50-2	5/8
1339600	2050	1 1/4
1337200	60	3/4
1339100	60-2	3/4
1337500	60H	3/4
1339200	60H-2	3/4
1337300	60LL	3/4
1339700	2060	1 1/2
1339850	2060H	1 1/2
1337900	80	1
1339300	80-2	1
1338300	80H	1
1337700	80LL	1
1337800	80SB	1
1338400	100	1 1/4
1339400	100-2	1 1/4
1338500	120	1 1/2
1338600	140	1 3/4
1338700	160	2

WELD A HUB

Black Oxide Finish
Call for Sizes
& Quotes

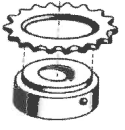

ITEM NO.	SIZE	BORE
1211000	V	1/2
1211100	V	9/16
1211200	V	5/8
1211300	V	11/16
1211400	V	3/4
1211500	V	13/16
1211600	V	7/8
1211700	W	1/2
1211800	W	9/16
1211900	W	5/8
1212000	W	11/16
1212100	W	3/4
1212200	W	13/16
1212300	W	7/8
1212400	W	15/16
1212500	W	1
1212800	W	1 1/16
1212900	W	1 1/8
1213000	W	1 3/16
1213100	W	1 1/4
1213400	X	5/8
1213500	X	3/4
1213600	X	7/8
1213700	X	15/16
1213800	X	1
1214100	X	1 1/16
1214200	X	1 1/8
1214300	X	1 3/16
1214400	X	1 1/4
1214500	X	1 5/16
1214600	X	1 3/8
1214800	X	1 7/16
1214900	X	1 1/2
1215400	Y	1
1215500	Y	1 1/8
1215600	Y	1 1/4
1215300	Y	1 1/2
1215700	Y	1 3/4
1215800	Y	1 15/16
1215900	Y	2

CHAIN BREAKERS

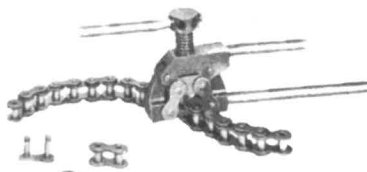

ITEM NO.	PART NO.	FOR CHAIN SIZE
1457000	#60	#35, #40, #50, #60
1457300	#100	#80, #100

CHAIN

PULLERS



ITEM NO.	PART NO.	FOR CHAIN SIZE
1456900	#35	#35, #40, #50, #60

Browning

BROWNING — MAYO

LEADERS IN POWER TRANSMISSION PRODUCTS

Mayo

Mayo

Ph: 1.800.223.5873 • Fax: 218.773.0995 • www.mayomfg.com

MasterCard • Visa

WELD A HUB & SPROCKETS



IOWA
Export-Import

Global Solutions™

WELD A SPROCKETS

**Black Oxide Finish
Call for Sizes
& Quotes**

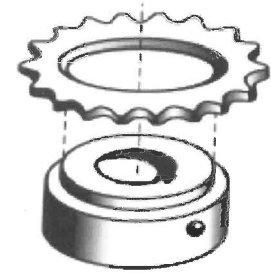

ITEM NO.	SIZE	HUB REQ.	ITEM NO.	SIZE	HUB REQ.	ITEM NO.	SIZE	HUB REQ.
1216400	4014	V	1220300	5024	X	1224300	6027	X
1216600	4016	W	1220400	5025	X	1224400	6028	X
1216700	4017	W	1220500	5026	X	1224500	6029	X
1216800	4018	W	1220600	5027	X	1224600	6030	X
1216900	4019	X	1220700	5028	X	1224800	6034	X
1217000	4020	X	1220800	5029	X	1224900	6035	X
1217100	4021	X	1220900	5030	X	1225000	6036	X
1217200	4022	X	1221000	5031	X	1225100	6038	X
1217300	4024	X	1221100	5032	X	1225200	6040	X
1217400	4025	X	1221200	5034	X	1225300	6042	X
1217500	4026	X	1221300	5035	X	1225400	6045	X
1217600	4028	X	1221650	5036	X	1225500	6048	X
1217700	4030	X	1221690	5040	X	1225600	6050	X
1217800	4032	X	1221600	5042	X	1225700	6052	X
1217900	4034	X	1221700	5045	X	1225800	6060	X
1218000	4035	X	1221850	5048	X			
1218100	4036	X	1221900	5050	X			
1218200	4038	X	1222000	5060	X			
1218300	4040	X	1222100	5072	X			
1218400	4042	X	1222200	5096	X			
1218500	4045	X	1222300	6009	V			
1218600	4054	X	1222400	6010	V			
1218700	4060	X	1222600	6011	W			
1218800	4072	X	1222700	6012	W			
1218900	5010	V	1222800	6013	W			
1219000	5011	V	1222900	6014	W			
1219100	5012	W	1223100	6015	X			
1219200	5013	W	1223200	6016	X			
1219300	5014	W	1223300	6017	X			
1219400	5015	W	1223400	6018	X			
1219500	5016	W	1223500	6019	X			
1219600	5017	X	1223750	6020	X			
1219700	5018	X	1223700	6021	X			
1219800	5019	X	1223850	6022	X			
1219900	5020	X	1223875	6023	X			
1220000	5021	X	1224000	6024	X			
1220100	5022	X	1224100	6025	X			
1220200	5023	X	1224200	6026	X			

WELD A SPROCKETS

FOR PINTLE CHAIN

ITEM NO.	SIZE	HUB REQ.
1226100	655	W
1226600	662	W
1226200	755	X
1226700	962	X
1226300	1055	X
1226800	1062	X
1226400	1255	X
1226900	1262	X
1226500	1455	X

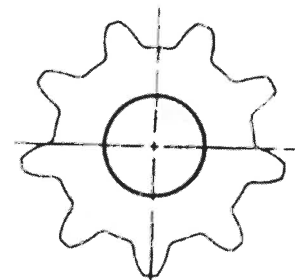

SHAFTS - PULLEYS - COUPLERS

KEYED

SHAFT

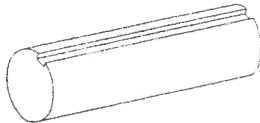

ITEM NO.	SIZE	LENGTH
1939100	3/4	6
1939200	7/8	6
1939300	1	6
1939600	1 1/4	6

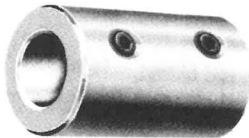

SHAFT COUPLER

ITEM NO.	SIZE	LENGTH
1251600	127-1200	3/4
1251700	127-1400	7/8
1251800	127-1600	1
1251900	127-1800	1 1/8
1252000	127-2000	1 1/4
1252100	127-2200	1 3/8
1252200	127-2300	1 7/16
1252300	127-2800	2 3/4
1252400	127-3200	2



WELDAPULLEY

- RIVETED GA METAL
- GALVANIZED

ITEM NO.	SIZE	RUB REQ.
1227000	2 1/2	V
1227100	3	V
1227200	3 1/2	X
1228100	4 1/2	X
1228200	5	X
1228300	5 1/2	X
1228400	6	X
1228600	7	X
1228700	8	X
1229000	9	X
1229100	10	X
1229150	12	X

CABLE PULLEYS



- Low Carbon Steel
- 7/8" Stock Bore
- Bushings Available

ITEM NO.	SIZE	THICKNESS
1229300	2	17/32
1229400	2	21/32
1299500	3	17/32
1229600	3	21/32

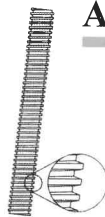

ACME THREADED

ROD

- Cut to Length
- Call for Quote

ITEM NO.	SIZE	LENGTH
1230200	5/8	6'
1230300	3/4	6'
1230400	1	6'
1230500	1 1/4	6'
1230600	1 1/2	6'

THREADED ROD

- Zinc Plated
- Course Thread
- Cut to Length
- Call for Quotes

ITEM NO.	SIZE	LENGTH
1231900	1/4	10'
1232000	5/16	10'
1232100	3/8	10'
1232200	7/16	10'
1232300	1/2	10'
1232400	5/8	10'
1232500	3/4	10'
1232600	7/8	10'
1232700	1	10'
1232800	1 1/2	10'

ACME NUTS

ITEM NO.	SIZE
1230800	5/8
1230700	3/4
1231500	1
1231600	1 1/4
1231800	1 1/2

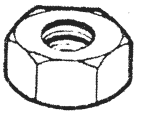

FINISHED BORE

SHEAVES

- Cast Iron
- Statically Balanced
- Standard Keyway
- Call for sizes & quotes

Single Groove for "A" Belts

ITEM NO.	PART NO.	BORE	OUTSIDE
			DIAM.
1143200	AK	1/2	1.75
1143300	AK17	5/8	1.75
1143500	AK20	5/8	2.00
1143700	AK22	5/8	2.20
1143600	AK25	1/2	2.20
1143800	AK25	5/8	2.50
1144300	AK25	3/4	2.50
1146800	AK27	1/2	2.70
1144400	AK28	1/2	2.80
1144600	AK28	5/8	2.80
1144500	AK28	3/4	2.80
1143900	AK30	5/8	3.05
1144000	AK34	5/8	3.45
1144100	AK34	3/4	3.45
1144200	AK34	7/8	3.45
1144700	AK39	5/8	3.75
1144800	AK39	3/4	3.75
1144725	AK39	1	3.75
1144750	AK40	1 1/8	3.95



WORLD-CLASS

Mayo

Ph: 1.800.223.5873 • Fax: 218.773.0995 • www.mayomfg.com

MasterCard • Visa

SHEAVES



FINISHED BORE SHEAVES

• Cast Iron • Statically Balanced • Standard Keyway

SINGLE GROOVE FOR "B" BELTS

ITEM NO.	PART NO.	OUTSIDE	
		BORE	DIA.
1132200	BK24	1/2	2.40
1132300	BK24	5/8	2.40
1132500	BK25	1/2	2.50
1132600	BK25	5/8	2.50
1132700	BK25	3/4	2.50
1132800	BK25	7/8	2.50
1133100	BK26	7/8	2.60
1133200	BK27	5/8	2.70
1133300	BK27	3/4	2.70
1133700	BK28	1/2	2.95
1133800	BK28	5/8	2.95
1133900	BK28	3/4	2.95
1134000	BK28	7/8	2.95
1134350	BK30	1/2	3.15
1134100	BK30	5/8	3.15
1134200	BK30	3/4	3.15
1134300	BK30	7/8	3.15
1134600	BK30	1	3.15
1134500	BK32	1/2	3.35
1134800	BK32	5/8	3.35
1134900	BK32	3/4	3.35
1135100	BK100	1	3.35
1135900	BK32	7/8	3.35
1136000	BK34	5/8	3.55
1136100	BK34	3/4	3.55
1136200	BK34	7/8	3.55
1136300	BK34	1	3.55
1136500	BK36	5/8	3.75
1136600	BK36	3/4	3.75
1136700	BK36	7/8	3.75
1136900	BK36	1	3.75
1137000	BK36	1 1/8	3.75
1137400	BK40	5/8	3.95
1137500	BK40	3/4	3.95
1137600	BK40	7/8	3.95
1137700	BK40	1	3.95
1138200	BK45	5/8	4.25
1138300	BK45	3/4	4.25
1138400	BK45	7/8	4.25
1138500	BK45	1	4.25
1139000	BK47	1	4.45
1139100	BK47	5/8	4.45
1139200	BK47	3/4	4.45
1139250	BK47	7/8	4.45
1139500	BK50	5/8	4.75

BUSHED-TYPE SHEAVES

SINGLE GROOVE FOR "A" BELTS

ITEM NO.	PART NO.	OUTSIDE	
		BORE	DIA.
1139600	BK50	3/4	4.75
1139700	BK50	7/8	4.75
1139800	BK50	1 1/8	4.75
1139900	BK52	5/8	4.95
1140400	BK55	3/4	5.25
1140650	BK55	1 1/8	5.25
1140700	BK57	1	5.45
1140800	BK57	1 1/8	5.45
1140850	BK60	5/8	5.75
1140900	BK60	7/8	5.75
1141400	BK62	1	5.95
1141850	BK80	3/4	7.75
1142000	BK80	1	7.75

ITEM NO.	PART NO.	BUSH OUTSIDE	
		REQ.	DIA.
1160300	AK30H	H	3.05
1160400	AK54H	H	5.25
1160500	AK69H	H	6.75
1155200	BK80H	H	7.75
1155300	BK85H	H	8.25
1155400	BK90H	H	8.75
1155500	BK95H	H	9.25
1155600	BK100H	H	9.75
1155700	BK105H	H	10.25
1155800	BK110H	H	10.75
1155900	BK120H	H	11.75
1156000	BK130H	H	12.75
1156100	BK140H	H	13.75
1160200	BK150H	H	15.75
1156200	BK160H	H	15.75
1156300	BK190H	H	18.75

Browning

SINGLE GROOVE FOR "B" BELTS

ITEM NO.	PART NO.	BUSH OUTSIDE	
		REQ.	DIA.
1134610	BK30H	H	3.15
1153300	BK32H	H	3.35
1153400	BK34H	H	3.55
1153500	BK36H	H	3.75
1153600	BK40H	H	3.95
1153700	BK45H	H	4.25
1153800	BK47H	H	4.45
1153900	BK50H	H	4.75
1154000	BK52H	H	4.95
1154100	BK55H	H	5.25
1154200	BK57H	H	5.45
1154300	BK60H	H	5.75
1154400	BK62H	H	5.95
1154500	BK65H	H	6.25
1154600	BK67H	H	6.45
1154700	BK70H	H	6.75
1154900	BK72H	H	6.95
1155000	BK75H	H	7.25
1155100	BK77H	H	7.45

Ph: 1.800.223.5873 • Fax: 218.773.0995 • www.mayomfg.com

MasterCard • Visa

Mayo

SHEAVES

DOUBLE GROOVE FOR "B" BELTS

ITEM NO.	PART NO.	BUSH OUTSIDE	
		REQ.	DIA.
1161200	2BK32H	H	3.35
1157200	2BK34H	H	3.55
1157400	2BK40H	H	3.95
1157500	2BK45H	H	4.25
1157600	2BK47H	H	4.45
1157700	2BK50H	H	4.75
1157800	2BK52H	H	4.95
1157900	2BK55H	H	5.25
1158000	2BK57H	H	5.45
1158100	2BK60H	H	5.75
1158200	2BK62H	H	5.95
1158400	2BK67H	H	6.45
1158500	2BK70H	H	6.75
1158600	2BK80H	H	7.75
1158700	2BK90H	H	8.75
1158800	2BK100H	H	9.75
1158900	2BK110H	H	10.75
1159000	2BK120H	H	11.75
1159100	2BK130H	H	12.75
1159200	2BK140H	H	13.75
1159300	2BK160H	H	15.75
1159400	2BK190H	H	18.75

TRIPLE GROOVE FOR "A" & "B" BELTS

ITEM NO.	PART NO.	BUSH OUTSIDE	
		REQ.	DIA.
1177500	3TB34	P2	3.75
1177700	3TB36	P2	3.95
1177800	3TB38	P1	4.15
1178100	3TB44	P1	4.75
1178200	3TB46	P1	4.95
1178400	3TB50	P1	5.35
1178600	3TB54	P1	5.75
1178900	3TB60	P1	6.30
1178950	3TB62	P1	6.55
1179200	3TB66	P1	6.95
1179300	3TB68	P1	7.15
1179350	3TB70	Q1	7.35
1179500	3TB74	Q1	7.75
1179600	3TB80	Q1	8.35
1179700	3TB86	Q1	8.95
1179800	3TB90	Q1	9.35
1179900	3TB94	Q1	9.75
1180000	3TB110	Q1	11.35
1180100	3TB124	Q1	12.75

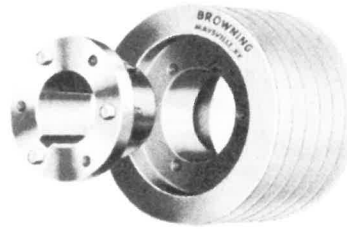

GRIPBELT SHEAVES WITH SPLIT TAPER BUSHINGS

ITEM NO.	PART NO.	BUSH OUTSIDE	
		REQ.	DIA.
1174400	2TB34	P1	3.75
1174500	2TB36	P1	3.95
1174600	2TB38	P1	4.15
1174700	2TB40	P1	4.35
1174800	2TB42	P1	4.55
1174900	2TB44	P1	4.75
1175000	2TB46	P1	4.95
1175100	2TB48	P1	5.15
1175300	2TB52	P1	5.55
1175400	2TB54	P1	5.75
1175500	2TB56	P1	5.95
1175700	2TB60	P1	6.30
1175900	2TB64	P1	6.75
1176000	2TB66	P1	6.95
1176200	2TB70	Q1	7.35
1176300	2TB74	Q1	7.75
1176400	2TB80	Q1	8.35
1176500	2TB86	Q1	8.95
1176600	2TB90	Q1	9.35
1176700	2TB94	Q1	9.75
1176800	2TB110	Q1	11.35
1176900	2TB124	Q1	12.75
1177000	2TB136	Q1	13.95
1177100	2TB154	Q1	15.75
1177300	2TB200	Q1	20.35

FOUR GROOVE FOR "A" & "B" BELTS

ITEM NO.	PART NO.	BUSH OUTSIDE	
		REQ.	DIA.
1181300	4TB34	P2	3.75
1181400	4TB36	P2	3.95
1181500	4TB38	P1	4.15
1181600	4TB40	P1	4.35
1181700	4TB42	P1	4.55
1181800	4TB44	P1	4.75
1181900	4TB46	P1	4.95
1182000	4TB48	P1	5.15
1182100	4TB50	P1	5.35
1182200	4TB52	P1	5.55
1182300	4TB54	P1	5.75
1182400	4TB56	P1	5.95
1182500	4TB58	P1	6.15
1182600	4TB60	P1	6.30
1182700	4TB62	P1	6.55
1182800	4TB64	P1	6.75
1182900	4TB66	P1	6.95
1183100	4TB70	Q1	7.35
1183500	4TB90	Q1	9.35
1183550	4TB94	Q1	9.75
1183700	4TB110	Q1	11.35
1183705	4TB86	Q1	8.95
1183800	4TB124	Q1	12.75

TRIPLE GROOVE FOR "B" BELTS

ITEM NO.	PART NO.	BUSH OUTSIDE	
		REQ.	DIA.
1159900	3BK60H	H	5.75
1160000	3BK65H	H	6.45

V-BELTS



Browning

"SUPER GRIPBELT" V-BELTS

ITEM NO.	PART NO.	OUTSIDE DIA.
1758700	A23	25.2
1758800	A24	26.2
1758900	A25	27.2
1759000	A26	28.2
1759100	A27	29.2
1759200	A28	30.2
1759300	A29	31.2
1759400	A30	32.2
1759500	A31	33.2
1759600	A32	34.2
1759700	A33	35.2
1759800	A34	36.2
1759900	A35	37.2
1760000	A36	38.2
1760100	A37	39.2
1760200	A38	40.2
1760300	A39	41.2
1760400	A40	42.2
1760500	A41	43.2
1760600	A42	44.2
1760700	A43	45.2
1760800	A44	46.2
1760900	A45	47.2
1761000	A46	48.2
1761100	A47	49.2
1761200	A48	50.2
1761300	A49	51.2
1761400	A50	52.2
1761500	A51	53.2
1761600	A52	54.2
1761700	A53	55.2
1761800	A54	56.2
1761900	A55	57.2
1762000	A56	58.2
1762100	A57	59.2
1762200	A58	60.2
1762300	A59	61.2
1762400	A60	62.2
1762500	A66	68.2
1762600	A73	75.2

ITEM NO.	PART NO.	OUTSIDE DIA.
1762800	A92	94.2
1762900	A100	102.2
1763000	A105	107.2
1763100	A110	112.2
1763200	A144	146.2
1763300	B25	28.0
1763400	B26	29.0
1763500	B28	31.0
1763600	B29	32.0
1763700	B30	33.0
1763800	B31	34.0
1763900	B32	35.0
1764000	B33	36.0
1764100	B34	37.0
1764200	B35	38.0
1764300	B36	39.0
1764400	B37	40.0
1764500	B38	41.0
1764600	B39	42.0
1764700	B40	43.0
1764800	B41	44.0
1764900	B42	45.0
1765000	B43	46.0
1765100	B44	47.0
1765200	B45	48.0
1765300	B46	49.0
1765400	B47	50.0
1765500	B48	51.0
1765700	B49	52.0
1765800	B50	53.0
1765900	B51	54.0
1766100	B52	55.0
1766200	B53	56.0
1766300	B54	57.0
1766400	B55	58.0
1766500	B56	59.0
1766600	B57	60.0
1766700	B58	61.0
1767100	B59	62.0
1767200	B61	64.0

ITEM NO.	PART NO.	OUTSIDE DIA.
1767300	B62	65.0
1767500	B63	66.0
1767700	B64	67.0
1767800	B65	68.0
1767900	B66	69.0
1768100	B67	70.0
1768200	B68	71.0
1768300	B69	72.0
1768400	B70	73.0
1768500	B71	74.0
1768600	B72	75.0
1768100	B73	76.0
1768800	B74	77.0
1768900	B75	78.0
1769000	B76	79.0
1769100	B77	80.0
1769200	B78	81.0
1769300	B79	82.0
1769400	B80	83.0
1769500	B81	84.0
1769600	B82	85.0
1769700	B83	86.0
1769800	B84	87.0
1769900	B85	88.0
1770000	B86	89.0
1770100	B87	90.0
1770200	B88	91.0
1770300	B89	92.0
1770400	B90	93.0
1770500	B91	94.0
1770600	B92	95.0
1770700	B93	96.0
1770800	B94	97.0
1770900	B95	98.0
1771000	B96	99.0
1771100	B97	100.0
1771200	B98	101.0
1771300	B100	103.0
1771400	B103	106.0
1771600	B105	108.0
1772600	B108	111.0
1772700	B112	115.0
1773000	B120	123.0
1773200	B124	127.0
1773500	B128	131.0
1774100	B136	139.0
1774400	B158	161.0
1774500	B195	198.0
1774600	C90	94.2

ELECTRIC MOTORS

BALDOR
MOTORS • DRIVERS • GENERATORS

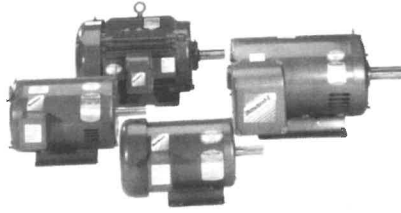

ELECTRIC MOTORS & COMPONENTS

• 1725 RPM • AMERICAN MADE
OTHER SIZES & TYPES AVAILABLE

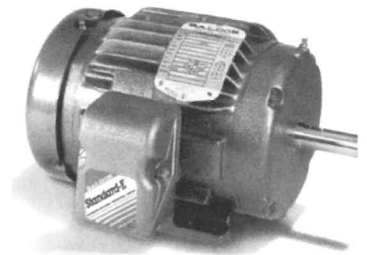

C-FLANGE TYPE

RIGID BASE

ITEM NO.	PART NO.	PHASE	HP	SFT. FRAME	SIZE
1967700	VFDL3504M	1	1/2	56C	5/8
1966100	VFDL3507M	1	3/4	56C	5/8
1967900	VFDL3510M	1	1	56C	5/8
1968000	VFDL3510TM	1	1	145TC	5/8
1968100	VFDL3514M	1	1 1/2	56C	5/8
1968200	VFDL3514TM	1	1 1/2	145TC	7/8
1968300	VFDL3611M	1	2	184C	7/8
1968400	VFDL3610M	1	3	184C	7/8
1968500	VFDL3610TM	1	5	184TC	1 1/8
1968600	VFDL3612TM	1	5	184TC	1 1/8
1968700	VFDL3732M	1	7 1/2	215C	1 1/8
1967800	VFDL3507M	3	3/4	56C	5/8
1972000	VM3538	3	1/2	56C	5/8
1972200	VM3542	3	3/4	56C	5/8
1972300	VM3546	3	1	56C	5/8
1972400	VM3546T	3	1	143TC	7/8
1974300	VM7014T	3	1	143TC	7/8
1973500	VM7014	3	1	56C	5/8
1972700	VM3554T	3	1 1/2	145TC	7/8
1974400	VM7034T	3	1 1/2	145T	7/8
1972600	VM3554	3	1 1/2	56C	5/8
1974500	VM7037T	3	2	145TC	7/8
1972900	VM3558	3	2	56C	5/8
1973300	VM3611	3	3	184C	7/8
1974600	VM7042T	3	3	182TC	1 1/8
1973500	VM3611T	3	3	182TC	1 1/8
1973600	VM3615	3	5	182TC	7/8
1973800	VM3615T	3	5	184TC	1 1/8
1974800	VM7044T	3	5	184TC	1 1/8
1974900	M7047T	3	7 1/2	213TC	1 3/8
1974000	VM3710T	3	7 1/2	182TC	1 1/8
1973900	VM3714T	3	10	215TC	1 3/8
1974100	VM2333T	3	15	254TC	1 5/8

ITEM NO.	PART NO.	PHASE	HP	SFT. FRAME	SIZE
1966000	FDL3504M	1	1/2	56	5/8
1966200	FDL3507M	1	3/4	56	5/8
1966400	FDL3510M	1	1	56	5/8
1966500	FDL3510TM	1	1	143T	7/8
1966600	FDL3514M	1	1 1/2	56	5/8
1966700	FDL3514TM	1	1 1/2	145T	7/8
1966800	FDL3611M	1	2	184	7/8
1966900	FDL3611TM	1	2	182T	1 1/8
1967000	FDL3610M	1	3	184	7/8
1967100	FDL3610TM	1	3	184T	1 1/8
1967200	FDL3612TM	1	5	184T	1 1/8
1967300	FDL3731M	1	5	215	1 1/8
1967400	FDL3732M	1	7 1/2	215	1 1/8
1967500	FDL3733TM	1	7 1/2	215T	1 3/8
1967550	FDL3737TM	1	10	215T	1 3/8
1969500	M3538	3	1/2	56	5/8
1969900	M3542	3	3/4	56	5/8
1969800	M3546T	3	1	143T	7/8
1972500	M3582T	3	1	145T	7/8
1969700	M3546	3	1	56	5/8
1969600	M3554	3	1 1/2	56	5/8
1970000	M3554T	3	1 1/2	145T	7/8
1970100	M3558	3	2	56	5/8
1970110	M3558T	3	2	145T	7/8
1970400	M3611	3	3	184	7/8
1970500	M3611T	3	3	182T	1 1/8
1970700	M3610T	3	3	182T	1 1/8
1971100	M3613T	3	5	184T	1 1/8
1971200	M3710T	3	7 1/2	213T	1 3/8
1971600	M3714T	3	10	215T	1 3/8
1971800	M2333T	3	15	254T	1 5/8
1971900	M2334	3	20	256T	1 5/8
1970900	M3615T	3	55	184T	1 1/8

C-FLANGE WITH BASE

ITEM NO.	PART NO.	PHASE	HP	FRAME	SHAFT SIZE
1968800	CFDL3510M	1	1	56C	5/8
1968900	CFDL3514M	1	1 1/2	56C	5/8
1969000	CFDL3514TM	1	1 1/2	145TC	7/8
1969100	CFDL3611M	1	2	184C	7/8
1969200	CFDL3610M	1	3	184C	7/8
1969300	CFDL3610TM	1	3	184TC	1 1/8
1969400	CFDL3612TM	1	5	184TC	1 1/8
1975000	CM3546	3	1	56C	5/8
1975300	CM3554	3	1 1/2	56C	5/8
1975400	CM3554T	3	1 1/2	145TC	7/8
1975600	CM3558T	3	2	145TC	7/8
1975700	CM3611	3	3	184C	7/8
1976000	CM3615T	3	5	184TC	1 1/8
1975900	CM3714T	3	10	215TC	1 3/8
1976100	CM2333T	3	15	254TC	1 5/8
1976200	CM2334T	3	20	256TC	1 5/8

VARIABLE SPEED MOTOR FREQUENCY DRIVES

- Up to 100 HP
- Input Single or Three Phase
- Output 3 Phase Only
- NEMA 4X Enclosure
- Call for Information



C-FLANGE REDUCER

ITEM NO.	PART NO.	MAX INPUT HP	INPUT RATIO	INPUT SHAFT	OUTPUT SHAFT
1808200	154Q56H10	.92	10:1	5/8	1
1809210	175Q56H20	.78	20:1	5/8	1
1808700	175Q56LR10	1.32	10:1	5/8	7/8
1808800	175Q56LR15	.99	15:1	5/8	7/8
1808900	175Q56LR20	.78	20:1	5/8	7/8
1809800	206Q56H10	1.95	10:1	5/8	1 7/16
1809900	206Q56H15	1.43	15:1	5/8	1 7/16
1810000	206Q56H20	1.16	20:1	5/8	1 7/16
1810550	206Q56H50	.54	50:1	5/8	1 7/16
1810200	206Q56LR10	1.95	10:1	5/8	1

SPEED REDUCERS

- Helical Shaft Mount
- Base Kit Not Included
- Bronze Wormgear
- Other Sized Available

ITEM NO.	PART NO.	MAX INPUT HP	INPUT RATIO	INPUT SHAFT	OUTPUT SHAFT
1810300	206Q56LR15	1.43	15:1	5/8	1
1810500	206Q56LR20	1.16	20:1	5/8	1
1810700	206Q56LR40	.66	40:1	5/8	1
1810800	206Q56LR50	.54	50:1	5/8	1
1811740	206Q140L20	1.16	20:1	7/8	1
1811000	206Q140LR10	1.95	10:1	5/8	1
1811000	206Q140LR15	1.43	15:1	5/8	1
1811300	206Q140LR20	1.16	20:1	7/8	1
1811200	206Q140R15	1.43	15:1	5/8	1
1811500	206Q140R20	1.16	20:1	7/8	1
1813200	237Q56H10	2.9	10:1	5/8	1 7/16
1813300	237Q56H15	2.19	15:1	5/8	1 7/16
1813400	237Q56H20	1.73	20:1	5/8	1 7/16
1813100	237Q56H30	1.26	30:1	5/8	1 7/16
1813600	237Q56H40	.99	40:1	5/8	1 7/16
1812400	237Q56LR10	2.9	10:1	5/8	1 1/8
1812500	237Q56LR15	2.19	15:1	5/8	1 1/8
1812600	237Q56LR20	1.73	20:1	5/8	1 1/8
1812800	237Q56LR50	.79	50:1	5/8	1 1/8
1813500	237Q140H10	2.9	10:1	7/8	1 7/16
1813700	237Q140H15	2.19	15:1	7/8	1 7/16
1813800	237Q140H20	1.73	20:1	7/8	1 7/16
1814000	237Q140LR15	2.19	15:1	7/8	1 1/8
1813900	237Q140LR10	2.9	10:1	7/8	1 1/8
1814200	237Q140LR15	2.19	15:1	7/8	1 1/8
1814300	237Q140LR20	1.73	20:1	7/8	1 1/8
1814400	237Q140LR30	1.26	30:1	7/8	1 1/8
1814100	237Q140R15	2.19	15:1	7/8	1 1/8
1815500	262Q56H30	1.48	30:1	5/8	1 15/16
1815700	262Q56LR30	.82	30:1	5/8	1
1816775	262Q140H10	3.54	10:1	7/8	1 15/16
1816800	262Q140H15	2.61	15:1	7/8	1 15/16
1816900	262Q140H20	2.09	20:1	7/8	1 15/16
1816100	262Q140L15	2.61	15:1	7/8	1 1/8
1816300	262Q140L20	2.09	20:1	7/8	1 1/8
1817110	262Q140L30	1.48	30:1	7/8	1 1/8
1815900	262Q140LR10	1.95	10:1	7/8	1
1816000	262Q140LR15	1.43	15:1	7/8	1
1816400	262Q140LR20	1.73	20:1	7/8	1 1/8
1816200	262Q140R15	2.61	15:1	7/8	1 1/8
1816210	262Q140R50	.96	50:1	7/8	1 1/8
1816700	262Q180LR10	3.54	10:1	1 1/8	1 1/8
1818700	300Q56H30	2.29	30:1	5/8	2 3/16
1818900	300Q56H40	1.77	40:1	5/8	2 3/16

Ph: 1.800.223.5873 • Fax: 218.773.0995 • www.mayomfg.com

MasterCard • Visa

Mayo

SPEED REDUCERS

ITEM NO.	PART NO.	MAX INPUT HP	INPUT RATIO	INPUT SHAFT	OUTPUT SHAFT
1819100	300Q140H20	3.13	20:1	7/8	2 3/16
1819140	300Q140H30	2.29	30:1	7/8	2 3/16
1819160	300Q140L30	2.29	30:1	7/8	1 1/4
1819200	300Q140LR10	5.25	10:1	7/8	1 1/4
1819400	300Q140LR20	3.13	20:1	7/8	1 1/4
1810573	300Q140R20	3.13	20:1	7/8	1 1/4
1819180	300Q140R30	2.29	30:1	1 1/8	2 3/16
1819300	300Q180H10	5.25	10:1	1 1/8	2 3/16
1819310	300Q180H20	3.13	20:1	1 1/8	2 3/16
1819500	300Q180L20	3.13	20:1	1 1/8	1 1/4
1819600	300Q180LR10	5.25	10:1	1 1/8	1 1/4
1819610	300Q180LR20	3.13	20:1	1 1/8	1 1/4
1822200	325Q56H40	2.11	40:1	5/8	2 3/16
1810574	325Q140H20	3.72	20:1	7/8	2 3/16
1810575	325Q140H30	2.73	30:1	7/8	2 3/16
1821800	325Q140H40	2.91	40:1	7/8	2 7/16
1820100	325Q140LR10	6.29	10:1	7/8	1 3/8
1820200	325Q140LR15	4.71	15:1	7/8	1 3/8
1820500	325Q180LR10	6.29	10:1	1 1/8	1 3/8
1820900	325Q180LR15	4.71	15:1	1 1/8	1 3/8
1822800	375Q210LR10	8.53	10:1	1 3/8	1 5/8

ITEM NO.	PART NO.	MAX INPUT HP	INPUT RATIO	INPUT SHAFT	OUTPUT SHAFT
1818400	262ULR30	1.48	30:1	3/4	1 1/8
1817900	262UR15	2.61	15:1	3/4	1 1/8
1819800	300ULR10	5.25	10:1	7/8	1 1/2
1821200	325ULR10	6.29	10:1	7/8	1 3/8
1821500	325ULR15	4.71	15:1	7/8	1 3/8
1822050	375UL10	8.53	10:1	1	1 5/8
1822000	375ULR10	8.53	10:1	1	1 5/8
1822600	375ULR20	5.23	20:1	1	1 5/8
1822625	375UR10	8.53	10:1	1	1 5/8
1822650	375UR20	8.53	20:1	1	1 5/8

U-STYLE REDUCER

ITEM NO.	PART NO.	MAX INPUT HP	INPUT RATIO	INPUT SHAFT	OUTPUT SHAFT
1809400	175ULR10	1.32	10:1	5/8	7/8
1809500	175ULR15	.99	15:1	5/8	7/8
1809600	175ULR20	.78	20:1	5/8	7/8
1809700	175ULR30	.55	30:1	5/8	7/8
1809710	175ULR60	.30	60:1	5/8	7/8
1812350	206UL40	.66	40:1	5/8	1
1811600	206ULR10	1.95	10:1	5/8	1
1811800	206ULR15	1.43	15:1	5/8	1
1811900	206ULR20	1.16	20:1	5/8	1
1812100	206ULR40	.66	40:1	5/8	1
1812200	206ULR50	.54	50:1	5/8	1
1814600	237ULR10	2.9	10:1	3/4	1 1/8
1814700	237ULR15	2.19	15:1	3/4	1 1/8
1814800	237ULR20	1.73	20:1	3/4	1 1/8
1814900	237ULR30	1.26	30:1	3/4	1 1/8
1815000	237ULR40	.99	40:1	3/4	1 1/8
1817600	262UL10	3.54	10:1	3/4	1 1/8
1817800	262UL15	2.61	15:1	3/4	1 1/8
1818100	262UL20	2.09	20:1	3/4	1 1/8
1817400	262ULR10	3.54	10:1	3/4	1 1/8
1818200	262ULR15	2.61	15:1	3/4	1 1/8
1818300	262ULR20	2.09	20:1	3/4	1 1/8

STANDARD BASE KITS

ITEM NO.	PART NO.	SIZE FOR REDUCER
1824500	133-SBK	133
1824600	154-SBK	154
1824700	175-SBK	175
1825000	206-SBK	206
1825200	237-SBK	237
1825300	262-SBK	262
1825400	300-SBK	300
1825500	325-SBK	325
1825600	375-SBK	375
1825800	450-SBK	450

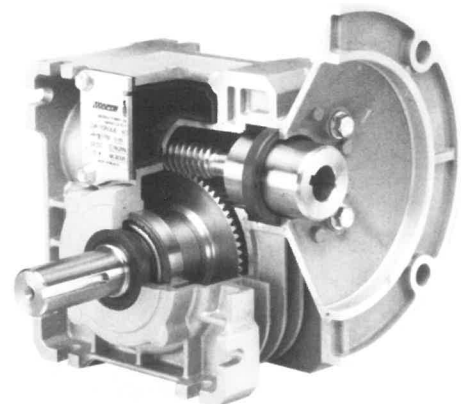

WINSMITH SPEED REDUCER

Base kit not included

C-FLANGE REDUCER

ITEM NO.	PART NO.	RATIO	ASSEMBLY	INPUT SHAFT	OUTPUT SHAFT
1822507	E20MDNS	20:1	R	7/8	1
1822550	E20MDNS	20:1	LR	7/8	1
1826228	E30MDNS	15:1	L	1 1/8	1 3/8
1827345	E24MDNS	20:1	R	5/8	1 1/4
1827346	E24MDNS	20:1	L	5/8	1 1/4
1827350	E30MDNS	10:1	R	1 1/8	1 3/8
1827351	E24MDNS	30:1	LR	5/8	1 1/4
1827365	E24MDNS	40:1	L	7/8	1 1/4
1827400	E26MDNS	20:1	LR	7/8	1 1/4
1827402	E43MDNS	20:1	LR	1 1/8	2
1827408	E30MDNS	20:1	L	1 1/8	1 3/8
1827409	E30MDNS	20:1	R	7/8	1 3/8
1827411	E30MDNS	20:1	R	1 1/8	1 3/8
1827412	E26MDNS	10:1	R	7/8	1 1/4
1827415	E30MDNS	15:1	R	1 1/8	1 3/8
1827418	E26MDNS	15:1	R	7/8	1 1/4
1827422	E26MDNS	15:1	L	7/8	1 1/4
1827435	E35MDNS	30:1	L	1 1/8	1 3/4
1827447	E35MDNS	20:1	L	1 1/8	1 3/4
1827495	E35MDNS	20:1	L	1 1/8	1 3/4
1827498	E35MDNS	15:1	L	1 1/8	1 3/4
1827499	E35MDNS	15:1	LR	1 1/8	1 3/4
1847410	E26MDNS	20:1	LR	7/8	1 1/4
1847485	E26MDNS	50:1	L	5/8	1 1/4
2103500	E17MDTS	10:1	R	5/8	1 1/4
2103525	E17MDTS	10:1	L	5/8	1 1/4
2103625	E17MDT	25:1	R	5/8	1 1/4
2103650	E17MDT	25:1	L	5/8	1 1/4
2103800	E17MDT	50:1	R	5/8	1 1/4
2103825	E17MDT	50:1	L	5/8	1 1/4
2103850	E17MSFS	50:1	L	5/8	1 1/4



BASE KITS

ITEM NO.	DESCRIPTION
1825434	920 BASE KIT
1825425	924 BASE KIT
1827410	926 BASE KIT
1827450	930 BASE KIT
1825430	935 BASE KIT

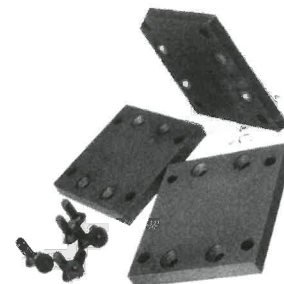

Ph: 1.800.223.5873 • Fax: 218.773.0995 • www.mayomfg.com

MasterCard • Visa

Mayo

HOLLOW SHAFT REDUCER

Base kit not included

ITEM NO.	PART NO.	INPUT SHAFT	BORE SIZE
1822509	E20 MDSS DLR	5/8	1 1/4
1822510	E20 MDSS DLR	5/8	1 1/4
1822520	E20 MDSS DLR	5/8	1 1/4
1822521	E20 MDSS DLR	5/8	1 7/16
1826000	E20 MDSS DLR	5/8	1 7/16
1826005	E20 MDSS DLR	5/8	1 1/4
1826010	E20 MDSS DLR	5/8	1 7/16
1826015	E20 MDSS DLR	5/8	1 7/16
1826020	E20 MDSS DLR	7/8	1 7/16
1826025	E20 MDSS DLR	7/8	1 1/4
1826030	E20 MDSS DLR	7/8	1 7/16
1826035	E20 MDSS DLR	7/8	1 1/4
1826040	E20 MDSS DLR	5/8	1 1/4
1826045	E20 MDSS DLR	5/8	1 7/16
1826050	E24 MDSS DLR	5/8	1 7/16
1826055	E24 MDSS DLR	5/8	1 1/4
1826060	E24 MDSS DLR	5/8	1 7/16
1826063	E24 MDSS DLR	5/8	1 1/2
1826064	E24 MDSS DLR	5/8	1 1/2
1826065	E24 MDSS DLR	7/8	1 7/16
1826070	E24 MDSS DLR	7/8	1 7/16
1826075	E24 MDSS DLR	7/8	1 7/16
1826080	E24 MDSS DLR	7/8	1 1/4
1826085	E24 MDSS DLR	7/8	1 7/16
1826090	E24 MDSS DLR	7/8	1 7/16
1826095	E26 MDSS DLR	5/8	1 7/16
1826100	E26 MDSS DLR	5/8	1 3/8
1826105	E26 MDSS DLR	5/8	1 1/4
1826110	E26 MDSS DLR	1 1/8	1 1/4
1826114	E26 MDSS DLR	5/8	1 7/16
1826115	E26 MDSS DLR	1 1/8	1 7/16
1826120	E26 MDSS DLR	1 1/8	1 7/16
1826125	E26 MDSS DLR	1 1/8	1 7/16
1826128	E26 MDSS DLR	7/8	1 1/4
1826135	E26 MDSS DLR	7/8	1 1/4
1826140	E26 MDSS DLR	7/8	1 7/16
1826145	E26 MDSS DLR	5/8	1 3/8
1826150	E26 MDSS DLR	5/8	1 1/4
1826155	E30MDSS DLR	5/8	1 3/8
1826160	E30MDSS DLR	1 1/8	1 7/16

ITEM NO.	PART NO.	INPUT SHAFT	BORE SIZE
1826165	E30MDSS DLR	1 1/8	1 7/16
1826170	E30MDSS DLR	1 1/8	1 3/4
1826175	E30MDSS DLR	1 1/8	1 7/16
1826180	E30MDSS DLR	1 1/8	1 7/16
1826185	E30MDSS DLR	7/8	1 7/16
1826190	E30MDSS DLR	7/8	1 7/16
1826195	E35MDSS DLR	1 1/8	1 7/16
1826200	E35MDSS DLR	1 1/8	1 3/4
1826205	E35MDSS DLR	1 1/8	1 7/16
1826210	E35MDSS DLR	1 1/8	1 3/8
1826215	E35MDSS DLR	1 1/8	1 7/16
1826220	E35MDSS DLR	1 1/8	1 3/8
1826225	E35MDSS DLR	1 1/8	1 7/16
1826226	E43 MDSS DLR	1 1/8	2
1826230	E43 MDSS DLR	1 1/8	1 1/2
1826235	E43 MDSS DLR	1 1/8	1 3/8
1827413	E24 MDSS DLR	7/8	1 7/16
1827417	E26 MDSS DLR	7/8	1 7/16



WINSMITH®

SPEED REDUCERS

BEARINGS

BEARING UNITS

- Cast Iron Housing
- Relube Inserts • Available with Set Screw

Call for Other Sizes & Quotes

PILLOW BLOCK BEARINGS

- Eccentric Lock Collar
- Available with Set Screw
- Relube Inserts



ITEM NO.	BEARINGS	I.D.
1368505	HCP207-20	1 1/4
1370105	HCP207-23	1 7/16
1370200	HCP208-24	1 1/2
1370950	HCP209-28	1 3/4
1370975	HCP210-32	2
1371025	HCP211-32	2

TAKE-UP

BEARINGS

- Eccentric Lock Collar
- Available with Set Screw
- Relube Inserts

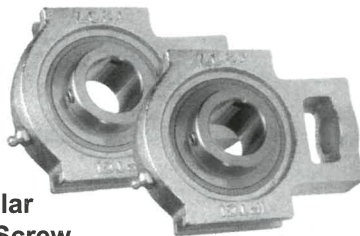

ITEM NO.	BEARINGS	I.D.
1372400	FHT207-20	1 1/4
1372500	FHT207-23	1 7/16

Let Mayo Help You With All of Your
Ag & Industrial Bearing Needs!



INTERCHANGE FOR

BEARING HOUSINGS

- Cast Iron Housings
- Comes with Zerk
- Call for Other Sizes

PILLOW BLOCK HOUSING

ITEM NO.	PART NO.	SIZE
1349800	P204-H	3/4
1350000	P205-H	1, 3/4
1350200	P206-H	1 1/8, 1 1/4S
1350600	P207-H	1 1/4, 1 7/16
1350800	P208-H	1 1/2
1351000	P209-H	1 3/4
1351200	P210-H	2
1351300	P211-H	2 1/5

4-BOLT FLANG HOUSING

ITEM NO.	PART NO.	SIZE
1351500	F205-H	1, 3/4
1351700	F206-H	1 1/8, 1 1/4S
1351800	F207-H	1 1/4, 1 7/16

2-BOLT FLANG HOUSING

ITEM NO.	PART NO.	SIZE
1353100	LF204	3/4
1353300	LF205-H	1, 3/4
1353400	LF206	1 1/8, 1 1/4S
1354200	LF207	1 1/4, 1 7/16

TAKE-UP HOUSING

ITEM NO.	PART NO.	SIZE
1355100	T205-H	1, 3/4
1355200	T206-H	1 1/8, 1 1/4S
1355400	T207-H	1 1/4, 1 7/16
1355600	T208-H	1 1/2
1355700	T209-H	1 3/4

Ph: 1.800.223.5873 • Fax: 218.773.0995 • www.mayomfg.com

MasterCard • Visa

Mayo

BEARING INSERTS

BEARING INSERTS



- Relubable • Precision Ground
- Available in Prelubed

Call for Other Sizes or Specialty Bearings



STANDARD INSERT WITH LOCK COLLAR

EXTENDED RACE INSERT WITH LOCK COLLAR

EXTENDED RACE TRIPLE SEAL INSERT WITH LOCK COLLAR

ITEM NO.	PART NO.	BORE
1310700	FH204-12N	3/4
1310800	FH204-12G	3/4
1310850	FH205-14G	7/8
1312700	FH205-16N	1
1312860	FH206-18	1 1/8
1312825	FH206-18G	1 1/8
1312865	FH206-19N	1 1/5
1313100	FH206-20N	1 1/4
1313500	FH207-20N	1 1/4
1312100	FH207-21N	15/16
1311300	FH207-22N	1 3/8
1311000	FH207-23N	1 7/16
1311350	FH208-24N	1 1/2
1312200	FH209-26N	1 5/8
1311400	FH209-28N	1 3/4
1312400	FH210-31N	1 15/16
1311500	FH210-32N	2
1314500	FH211-32N	2

ITEM NO.	PART NO.	BORE
1313400	HC206-19G	1 3/16
1313300	HC206-20	1 1/4
1313800	HC207-20G	1 1/4
1314000	HC207-22	1 3/8
1311100	HC207-23	1 7/16
1313900	HC208-24G	1 1/2
1314100	HC209-28G	1 3/4
1311800	HC210-31	1 15/16
1314600	HC210-32	2
1314400	HC211-32	2

ITEM NO.	PART NO.	BORE
1312005	HC205-16TRL	1
1310900	HC206-20TRL	1 1/4
1313850	HC207-20TRL	1 1/4
1311150	HC207-23TRL	1 7/16
1311850	HC210-31TRL	1 15/16
1314700	HC210-32TRL	2
1314800	HC211-32TRL	2
1314900	HC211-35TRL	2 3/16
1314950	HC212-39TRL	2 7/16

The triple lip seals is one piece shroud cover with three molded contact rubber seals. Suggested for use in severe contamination and moisture environments.

STANDARD INSERT WITH SET SCREW



EXTENDED RACE TRIPLE SEAL INSERT WITH SET SCREW



EXTENDED TRIPLE SEAL INSERT WITH SET SCREW

ITEM NO.	PART NO.	BORE
1313000	FHS205-16	1
1313075	FHS205-16G	1
1313010	FHSR205-16	1
1313110	FHSR206-20	1 1/4

ITEM NO.	PART NO.	BORE
1308600	UC207-20	1 1/4
1308800	UC207-23	1 7/16
1308900	UC208-24	1 1/2
1368350	UC210-31	1 15/16
1307600	UC211-32	2

ITEM NO.	PART NO.	BORE
1309305	UC205-16TRL	1
1308700	UC207-20TRL	1 1/4
1315000	UC207-23TRL	1 7/16

BEARINGS

RADIAL BEARINGS

- Rubber Seals on Both Sides
- Available with Steel Shields

Call for Quotes & Other Sizes

ITEM NO.	PART NO.
1273700	6203-2RS
1274000	6203-ZZ
1274400	6204-2RS
1275100	6205-ZZ
1275200	6206-ZZ
1276000	6305-2RS



PRESSED STEEL HOUSINGS

3-BOLT FLANGETTE



ITEM NO.	SIZE	FOR BEARINGS
1342500	40MM	1/2, 5/8
1342600	47MM	3/4
1342800	52MM	7/8, 1
1343000	62MM	1 1/8, 1 1/4S
1343100	72MM	1 1/4, 1 7/16

AGRICULTURAL BEARINGS

ITEM NO.	PART NO.
1276300	203-KRR2
1276400	203-KRR6
1278800	204-BBAR
1277170	205-KRP2



2-BOLT FLANGETTE

ITEM NO.	SIZE	FOR BEARINGS
1342200	47MM	3/4
1342300	52MM	7/8, 1
1342400	62MM	1 1/8, 1 1/4S

TRUST BEARINGS

ITEM NO.	PART NO.	I.D.	O.D.
1282700	T126	1.26"	2 3/16"

2-BOLT STRAND



ITEM NO.	SIZE	FOR BEARINGS
1341900	47MM	3/4
1342000	52MM	7/8, 1
1342100	62MM	1 1/8, 1 1/4S

**SPECIAL
APPLICATION
BEARINGS
CALL FOR QUOTES!**

MISC. STEEL HOUSINGS

*Call for
Quotes and
More Information*



Ph: 1.800.223.5873 • Fax: 218.773.0995 • www.mayomfg.com

MasterCard • Visa

Mayo

BEAN EQUIPMENT PARTS

WE SUPPLY BEAN COMPANIES AND GROWERS WITH PARTS

BUCKETS

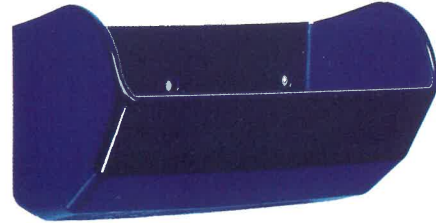
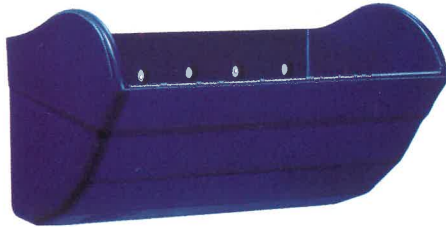

PUNCHED BELTING



ELEVATOR BOLTS



CLIPPER STAINLESS STEEL UNIBAR



FLEXCO ALLIGATOR FASTENERS



SCREENER

* CUSTOM BUILT *



Mayco

Ph: 1.800.223.5873 • Fax: 218.773.0995 • www.mayomfg.com

MasterCard • Visa

BEAN EQUIPMENT PARTS

WE SUPPLY BEAN COMPANIES AND GROWERS WITH PARTS

BELTING

CRESCENT TOP PVG

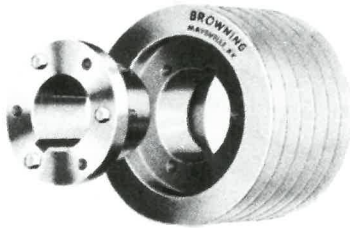

FLIGHTED BELTING

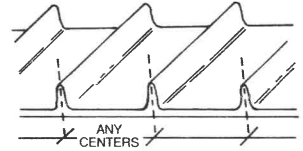

BEARINGS, PULLEYS, SHEAVES, & V-BELTS

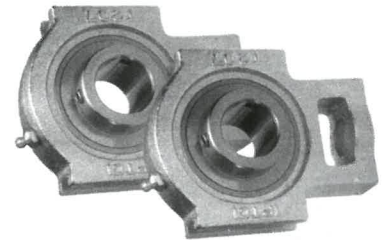

ROLLER LACERS

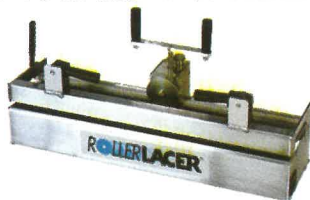

HEAD & TAIL ROLLERS



Ph: 1.800.223.5873 • Fax: 218.773.0995 • www.mayomfg.com

MasterCard • Visa

Mayo

HYDRAULIC COMPONENTS



HYDRAULIC CYLINDERS

- 2500 PSI
- Precision Cylinder Barrels
- Hardened Rods
- Cast Clevises
- Seal Kits Available

ITEM NO.	BORE	STROKE	ROD DIA.	RET DIA.
1835000	2	08	1 1/8	18 1/4
1835300	2	10	1 1/8	20 1/4
1835500	2	12	1 1/8	22 1/4
1835700	2	14	1 1/8	24 1/4
1835900	2	16	1 1/8	26 1/4
1836100	2	18	1 1/8	28 1/4
1836500	2	24	1 1/8	34 1/4
1837300	2 1/2	14	1 1/8	24 1/4
1838000	2 1/2	30	1 1/8	40 1/4
1838200	3	6	1 1/4	16 1/4
1838300	3ASAE	8	1 1/4	20 1/4
1838700	3	10	1 1/4	20 1/4
1838900	3	12	1 1/4	22 1/4
1839100	3	14	1 1/4	24 1/4
1839300	3	16	1 1/4	26 1/4
1839600	3	18	1 1/4	28 1/4
1839800	3	20	1 1/4	30 1/4
1840000	3	24	1 1/4	34 1/4
1840600	3 1/2	10	1 1/4	20 1/4
1840700	3 1/2	12	1 1/4	22-1/4
1841000	3 1/2	16	1 1/4	26-1/4
1842100	4	8	1 1/4	18-1/4
1842400	4	10	1 1/4	20-1/4
1842500	4	12	1 1/4	22-1/4
1842550	4	14	1 1/4	24 1/4
1842800	4	16	1 1/4	26 1/4
1843000	4	18	1 1/2	28 1/4
1843200	4	20	1 1/2	30 1/4
1843500	4	24	1 1/2	34 1/4
1844500	5	20	2	32 1/4



CYLINDER CLEVIS PIN

- Includes Pins
- Hardened Steel



ITEM NO.	DIAMETER	LENGTH
2100740	1	3 1/4
1484450	1	3 1/4

CYLINDER CLEVIS'



- Cast Steel
- Other Sizes Available

ITEM NO.	PIN DIAMETER	ROD DIAMETER
1484800	1	1-1/4
2100740	1	1-1/4



RATCHET JACKS

10,000 LB. CAP

ITEM NO.	PART NO.	RET. LENGTH	EXT. LENGTH
1465900	SL1541GT	20	29

BRAND HAND

PUMPS

ITEM NO.	PART NO.	MAX PSI
1891200	HP121-DATL	2,000 lb
1891000	HP121-DA95	2,000 lb



HYDRAULIC COMPONENTS



FLOW CONTROL VALVE

- Controls Flow of Motors
- Range is from Stop to Full Speed
- 3000 PSI Max.

ITEM NO.	PART NO.	MAX GPM	PORT SIZE
1871300	FC-51	8	3/8
1871500	FC-51	16	1/2
1871700	FC-51	30	3/4



PRESSURE GAUGE

- Stainless Steel Case

ITEM NO.	PART NO.	DIA.	PSI RANGE
1892750	213.53.2.2	2-1/2	3000



FLOW DIVIDER

- Divides to Two Equal Flows
- 3000 PSI Max.

ITEM NO.	PART NO.	MAX GPM	PORT SIZE
1871900	BG-52	25	3/4
1871800	BG-58	25	3/8

O-RING BOSS FITTINGS



- Steel Machines Fittings
- Call for Other Sizes



ITEM NO.	PART NO.	MALE O-RING	FEMALE PIPE NPT
1907800	6405-4-6	1/16	3/8
1907900	6405-6-6	9/16	3/8
1908000	6405-6-8	9/16	1/2
1908100	6405-8-4	3/4	1/4
1908200	6405-8-6	3/4	3/8
1908300	6405-8-8	3/4	1/2
1908400	6405-10-6	7/8	3/8
1908500	6405-10-8	7/8	1/2
1908700	6405-12-8	1 1/16	1/2
1908800	6405-12-12	1 1/16	3/4
1908850	6405-16-8	1 5/16	1/2
1908950	6405-16-16	1 5/16	1
1909600	6901-6-6	9/16	3/8

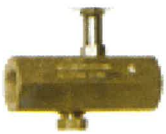

FLOW CONTROL

ITEM NO.	PART NO.	PORT SIZE
1872200	KLF375SBC	3/8
1872300	KLF500SBC	1/2

POWER UNITS

- AC Units - DC Units Available
- Used in Most Appliances
- Call for Specifications for any Power Unit

ITEM NO.	HP	PHASE	MAX GPM	GAL
1883860	5	1	5	15

GREASE ZERKS

ITEM NO.	SIZE	TYPE
2100810	1/4	Straight
2100815	1/4	45°
2100820	1/4	90°
2100825	1/8	Straight
2100830	1/8	45°
2100835	1/8	90°



O-RINGS

We have a full selections of Rubber O-Rings

CALL FOR SIZES AND QUOTES



Ph: 1.800.223.5873 • Fax: 218.773.0995 • www.mayomfg.com

MasterCard • Visa

Mayo

HYDRAULIC COMPONENTS

HYDRAULIC HOSE & FITTINGS



- One & Two Wire
- American Made
- Will Cut to Length
- Will Crimp Ends Here

ONE WIRE HOSE

ITEM NO.	PART NO.	SIZE
1918000	AX04	1/4
1918200	AX06	3/8
1918210	AX08	1/2
1918220	AX12	3/4

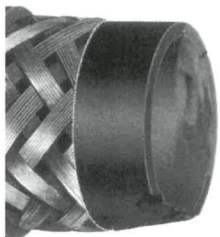

TWO WIRE HOSE

ITEM NO.	PART NO.	SIZE
1918300	FX06	3/8

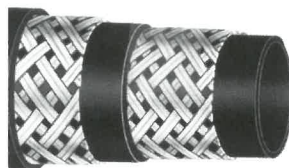

HYDRAULIC HOSE ENDS

- NPT Pipe Thread
- Available with Female Pipe Fittings
- Mayo Can Make Any Size Hose

ITEM NO.	PART NO.	THREAD SIZE	HOLE SIZE
1910000	4NP-4SB	1/4	1/4
1912000	6MS-6SB	3/8	3/8
1912400	8NP-6SB	1/2	3/8
1913900	16MS-16SB	1	1

WE MAKE HOSE ASSEMBLIES!



- MAYO WILL MAKE HOSES CUT TO ANY LENGTH.
- CHOOSE FROM 1 OR 2 WIRE HOSE & RIGED OR SWIVEL FITTINGS.



STEEL FITTINGS



BUSHINGS



ELBOWS



STREET ELBOWS



TEES



STRAIGHT SWIVEL

- NPT Thread



45° SWIVEL

- NPT Thread



90° SWIVEL

- NPT Thread



HYDRAULIC QUICK DISCONNECT



COUPLERS



STRAIGHT UNION

- NPT Thread

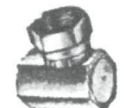

90° UNION

- NPT Thread

COUPLINGS

SET COLLAR

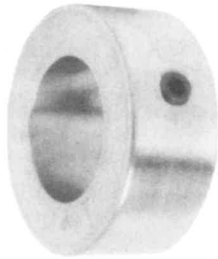

- Zinc Plated
- Single Set Screw
- Available in Stainless Steel

JAW COUPLING & INSERTS

- Available in Bush-Type
- Other Sizes Available
- Call for Sizes & Quotes
- Lovejoy Type Available



COUPLING HALVES

ITEM NO.	PART NO.	BORE
1286000	SC-200	2
1286200	SC-218	2 3/16
1286300	SC-243	2 7/16
1283600	SC-25	1/4
1286400	SC-250	2 1/2
1286500	SC-300	3
1283700	SC-31	5/16
1283800	SC-37	3/8
1283900	SC-43	7/16
1284100	SC-50	1/2
1284200	SC-56	9/16
1284300	SC-62	5/8
1284400	SC-75	3/4
1284450	SC-87	7/8
1284500	SC-94	1 5/16
1284600	SC-100	1
1284700	SC-100SS	1
1284800	SC-106	1 1/16
1284900	SC-112	1 1/8
1285000	SC-118	1 3/16
1285050	SC-125	1 1/4
1285025	SC-125-2	1 1/4
1285200	SC-137	1 3/8
1285300	SC-143	1 7/16
1285400	SC-150	1 1/2
1285500	SC-162	1 5/8
1285600	SC-175	1 3/4
1283500	SC-18	3/16
1285700	SC-187	1 7/8
1285800	SC-193	1 15/16

ITEM NO.	PART NO.	O.D.	BORE
1246100	CHJP2	1 3/8	1/2
1246000	CHJP2	1 3/8	3/8
1246300	CHJP3	1 3/4	1/2
1246400	CHJP3	1 3/4	5/8
1246600	CHJP3	1 3/4	3/4
1246500	CHJP3	1 3/4	7/8
1246700	CHJP4	2 1/8	1/2
1247000	CHJP4	2 1/8	3/4
1246800	CHJP4	2 1/8	5/8
1247100	CHJP4	2 1/8	7/8
1247200	CHJP4	2 1/8	1
1247300	CHJP4	2 1/8	1 1/8
1247500	CHJP5	2 11/16	3/4
1247400	CHJP5	2 11/16	5/8
1247600	CHJP5	2 11/16	7/8
1247700	CHJP5	2 11/16	1
1248000	CHJP5	2 11/16	1 1/4
1247800	CHJP5	2 11/16	1 1/8
1248100	CHJP5	2 11/16	1 3/8
1248200	CHJP5	2 11/16	1 7/16
1248400	CHJS6	3 7/16	1
1248300	CHJS6	3 7/16	1 1/4
1248500	CHJS6	3 7/16	1 3/8
1240860	CHJS7	4 11/16	1 1/8
1248800	CHJS7	4 11/16	1 3/8
1249500	CHJS7	4 11/16	2 3/8

AVAILABLE IN:

- Neoprene
- Bronze
- Polyurethane

COUPLING INSERTS

ITEM NO.	PART NO.	MATERIAL
1244200	JZ2N	Neoprene
1244600	JZ3N	Neoprene
1245000	JS4N	Neoprene
1245200	JS5N	Neoprene
1245500	JS6N	Neoprene
1245600	JS7N	Neoprene
1244800	JS3U	Polyurethane
1245800	JS4U	Polyurethane
1245300	JS5U	Polyurethane
1245900	JS6U	Polyurethane
1245700	JS7U	Polyurethane
1244700	JS3B	Bronze
1244900	JS4B	Bronze
1245100	JS5B	Bronze
1245400	JS6B	Bronze

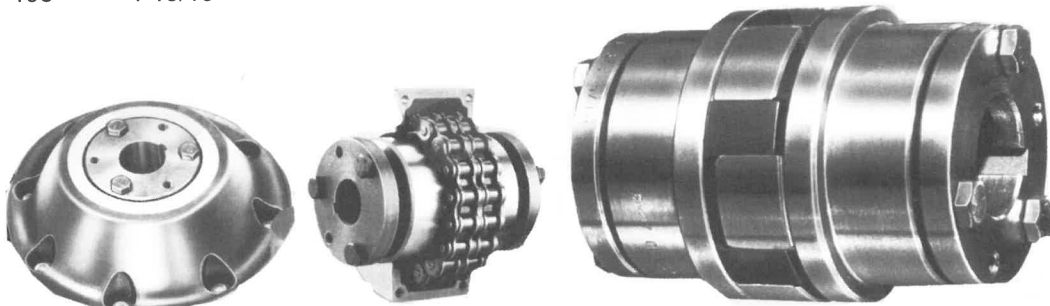

Ph: 1.800.223.5873 • Fax: 218.773.0995 • www.mayomfg.com

MasterCard • Visa

Mayo

ORBIT MOTORS

ORBIT MOTORS

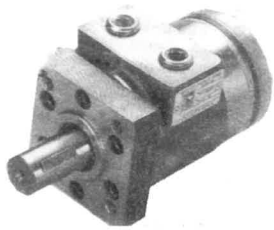

- Char-Lynn hydraulic motors are high-torque motors with fixed displacement.
- Smooth running over the entire speed range.
- High starting torque and high-efficiency.
- Long life under extreme operating conditions.
- Robust and compact design.
- High radial and axial bearing capacity.
- For applications in both open and closed loop hydraulic systems.
- All Char-Lynn motors have a case drain.
- Suitable for a wide variety of hydraulic fluids.
- Seal kits available.



Applications include:

- Machines for agriculture and forestry.
- Mining machinery.
- Contractor's equipment and access platforms.
- Grass cutting machinery.
- Cranes and transports.
- Special vehicles.
- Ship's equipment and winches on fishing vessels.
- Machine tools.
- Woodworking and sawmill machinery.
- Plastic and rubber machinery.

4-BOLT FLANG - H SERIES

ITEM NO.	PART NO.	PORT SIZE	MAX		MAX		PSI (CONT.)	SHAFT SIZE
			CU IN DISPL.	RPM	TORQUE (IN LBS.)	GPM		
1875200	101-1001	1/2 NPT	3.0	1249	565	16	2000	1
1875300	101-1002	1/2 NPT	4.8	778	907	16	2000	1
1875400	101-1003	1/2 NPT	5.9	622	1134	16	2000	1
1875500	101-1004	1/2 NPT	9.5	389	1814	16	2000	1
1875600	101-1005	1/2 NPT	11.9	311	2267	16	2000	1
1875700	101-1006	1/2 NPT	14.8	250	2633	16	2000	1
1875800	101-1007	1/2 NPT	18.7	198	2615	16	2000	1
1875900	101-1008	1/2 NPT	23.8	156	2722	16	2000	1
1876000	101-1009	7/8 14	3.0	1249	565	16	2000	1
1876100	101-1013	7/8 14	11.9	311	2267	16	2000	1
1876200	101-1015	7/8 14	18.7	198	2615	16	2000	1

2-BOLT FLANG - H SERIES

ITEM NO.	PART NO.	PORT SIZE	MAX		MAX		PSI (CONT.)	SHAFT SIZE
			CU IN DISPL.	RPM	TORQUE (IN LBS.)	GPM		
1876000	101-1009	1/2 NPT	2.8	969	650	12	1800	1
1876500	101-1028	1/2 NPT	9.5	389	1814	16	2000	1
1876700	101-1032	1/2 NPT	18.7	198	2615	16	2000	1
1876950	101-1036	7/8 14	9.5	389	1814	16	2000	1

2-BOLT FLANG - 2000 SERIES

ITEM NO.	PART NO.	PORT SIZE	MAX		MAX		PSI (CONT.)	SHAFT SIZE
			CU IN DISPL.	RPM	TORQUE (IN LBS.)	GPM		
1878900	104-1024	7/8 14	7.67	600	2850	20	2500	1 1/4
1878950	104-1026	7/8 14	11.89	350	4780	20	3000	1 1/4
1879600	104-1025	7/8 14	9.74	470	3100	20	2200	1 1/4
1879650	104-1194	7/8 14	6.2	500	2630	15	3000	1
1879100	104-1027	7/8 14	15.25	300	4100	20	1800	1 1/4
1876055	104-1028	7/8 14	19.21	240	4800	20	1700	1 1/4
1879700	104-1228	7/8 14	23.98	180	4450	20	1550	1 1/4
1879800	104-1420	7/8 14	29.84	115	7470	20	1750	1 1/4

BELT LACE



Clipper

BELT LACE

- 12 Feet Per Box
- Various Connecting Rods Available
- Call for Other Sizes and Quotes



STAINLESS STEEL UNIBAR

ITEM NO.	PART NO.	SIZE	BELT SIZE
1496400	01144	#U1	1/8
1496450	01231	#U2	5/32
1496600	01255	#U3	3/16
1496605	18400	#U2	5/32
1496610	18478	#U3	3/16
1496700	01283	#U4	1/4
1496800	01305	#U5	5/16

ROLLER LACER



ITEM NO.	PART NO.	LENGTH
1498400	03371	36
1498500	03372	48

MICRO LACER

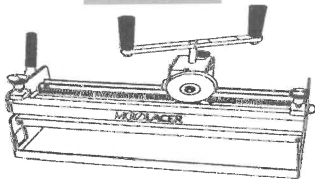

ITEM NO.	PART NO.	LENGTH
1498200	03368	14"

BALER LACER

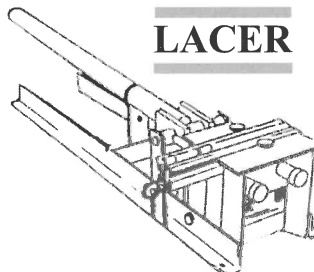

CALL FOR MORE INFORMATION

GALVANIZED



ITEM NO.	PART NO.	SIZE	BELT SIZE
1494700	02100	#1	1/8
1494800	02154	#2	5/32
1495000	02182	#3	3/16
1495100	02216	#4	1/4
1495300	02300	#4 1/2	9/32
1495400	02323	#5	5/16
1495500	02348	#6	3/8
1495900	02185	#3	3/16

STAINLESS STEEL



ITEM NO.	PART NO.	SIZE	BELT SIZE
1495900	02185	#3	3/16
1496100	02219	#4	1/4
1496200	02326	#5	5/16
1496300	02351	#6	3/8

VALUE LACER

ITEM NO.	PART NO.	LENGTH
1498900	3019	7'

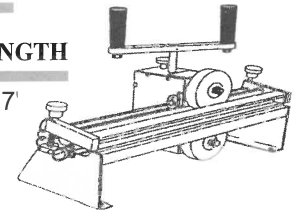

LACERS

Different Size Face
Plates Available

Call for Quotes

VICE LACER

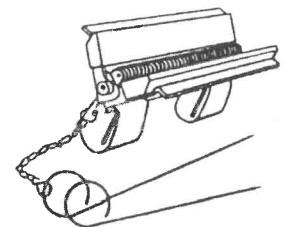

CALL FOR MORE INFORMATION

Ph: 1.800.223.5873 • Fax: 218.773.0995 • www.mayomfg.com

MasterCard • Visa

Mayo

TRAILER COMPONENTS

SCREW JACKS

- Acme Thread
- Call For Other Sizes
- Call For Quotes



SIDEWIND JACKS

ITEM NO.	PART NO.	RETR.		ATTACH.	
		LGTH.	TRAVEL	TYPE	CAP.
1464400	SWS15DTSF	11 1/4	10	Tube	2000LB
1464900	SWS198DTSM	10	10	Tube	7000 LB
1464800	SWL190DL	23 3/4	15		7000 LB
1464600	SWQ180DL8	27 1/2	26		12,000 LB

TOPWIND JACKS

ITEM NO.	PART NO.	RETR.		ATTACH.	
		LGTH.	TRAVEL	TYPE	CAP.
1465200	TWS151DS	11 1/4	10	Ret. Ring	2000 LB
1465300	TWS171DS	11 1/4	10	Ret. Ring	5000 LB
1465100	TWS158DTSF	11 1/4	10	Tube	2000 LB
1465000	TWS178DTSF	11 1/4	10	Tube	5000 LB
1465400	TWL158DTSF	14 1/4	15 1/4	Tube	2000 LB
1465700	TWL178DTSF	14 1/4	15	Tube	5000 LB
1465500	TWL190DL	23 3/4	15		7000 LB

HITCH COUPLER

ITEM NO.	SIZE	CAP.
1993300	2	5000 LB



PINTLE HOOK

ITEM NO.	PART NO.	CAP.
1993800	24WFC	40,000 LB



STEEL HUB ASSEMBLY

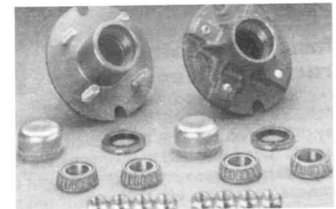

ITEM NO.	PART NO.	CAP.
1992500	53-680	1250 LB

TRAILER BALL

ITEM NO.	SIZE	SHANK	CAP.
1992600	1 7/8	3/4	3000 LB
1992700	2	3/4	3000 LB
1992900	2	1	5000 LB



AXLE ASSEMBLIES

- Mayo carries the full line of Dexter Axle Assemblies

Call for specifications and quotes!



WHEELS



CASTERS

- Heavy Duty Roller Bearings
- Available in Light, Medium & Heavy Duty
- Available in Steel, Rubber Mold-On, Polyurethane
- Call for More Information



RUBBER MOLD ON CASTERS

ITEM NO.	STYLE	WHEEL SIZE	TOTAL HEIGHT	CAPACITY
1536100	SWIVEL	4x2	5 3/4	400 LB.
1536200	RIDGID	4X2	5 3/4	400 LB.
1536700	SWIVEL	6x2	7 1/2	410 LB.
1537100	RIDGID	6X2	7 1/2	410 LB.
1537700	SWIVEL	8X2	9 1/2	500 LB.
1537800	RIDGID	8X2	9 1/2	500 LB.

CARRIER ROLLERS



- 16 ga. Riveted Hubs
- 6203-2RS Sealed Bearings
- Heavy Duty Braided Rubber

ITEM NO.	PART NO.	O.D.	WIDTH	BORE
1512100	813T	4	1	5/8
1512400	821T	5	1	5/8

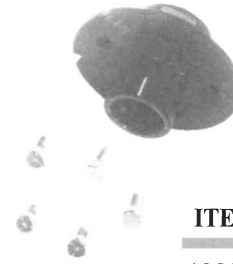

IMPLEMENT HUB

- Standard Duty
- All Steel Construction
- Call for Other Sizes

ITEM NO.	SIZE	BOLTS
1982900	15X6	6
1983000	15X8	6
1983300	15X10	8
1983900	22x5x8.25	8

IMPLEMENT RIM & TIRE



ITEM NO.	NO. BOLTS	RIM SIZE	TIRE SIZE	PLY RATING
1979300	4	15X4.5	7.60X16	6
1979350	5	15x4.5	7.60x16	6
1979500	6	15x6	7.60x16	6
1979700	6	15x6	11LX15	8
1979800	6	15X8	11LX15	8
1979850	6	15x6	11LX15	8
1980200	8	15X8	11LX15	8
1981300	4	12X4	4.80X12	PNUE
1981400	4	8X4	4.80X8	4

R & K ROLLERS



- Solid Cast Hubs
- Heavy Duty Flange Bearings

ITEM NO.	O.D.	WIDTH	BORE
1513000	5	1 1/2	3/4
1513100	6	1 1/2	3/4

BELTING

RUBBER BELTING

1/32 X 1/32
RUBBER ON
BOTH SIDES

ITEM NO.	WIDTH
2000100	3
2000200	10
2000600	12
2001100	18
2001300	20
2001600	24
2001900	30
2002000	36
2002200	48
2002100	60
2003200	72

1/32 X BB
RUBBER ON
ONE SIDE

ITEM NO.	WIDTH
1997400	12
1998100	18
1998500	24
1998600	30
1998700	36
1999600	48



DIAMOND TOP
BELTING

ITEM NO.	WIDTH
2003550	8
2003600	12
2003900	18
2004100	24
2004700	30
2005000	36



CRESCENT
TOP PVG

Many Sizes & Widths Available
Call For Quotes



HEAVY DUTY
WELDED
SELVAGE BELTING

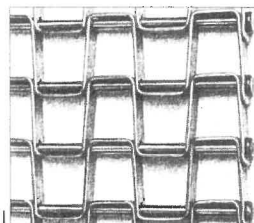

CHEVRON
TOP PVG

Many Sizes & Widths Available
Call For Quotes

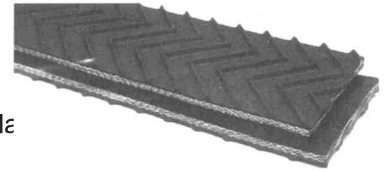

BUCKET
TOP PVG

Many Sizes & Widths Available
Call For Quotes



UHMW

ITEM NO.	WIDTH
1524300	1/8
1524400	3/16
1524500	3/8
1524600	1/2
1524700	1/4
1524800	3/4

- Self Lubricating
- Call For Other Sizes
- Full Sheets Come 4'x10'
- Can be Cut to any Size



FLIGHTED BELTING

Call For Sizes & Quotes

ITEM NO.	WIDTH
1525400	1/8

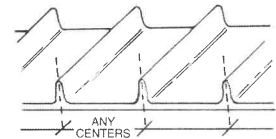

ROUGHTOP LAG

Call for Other

ITEM NO.	WIDTH
2005800	2

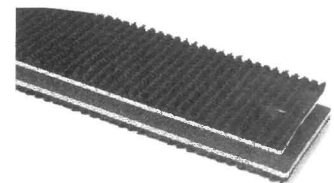

NOBRUZE FOAM PADDING

ITEM NO.	WIDTH
1525600	1/2
1525700	3/4
1525900	1

- 46" x 61" Sheets
- Glue Available

WELDED SELVAGE BELT SPECIFICATIONS

Design	Mesh	Width Min. Max	Max Tension (lbs/ft. of width)	Approx. Wgt (lbs./sq.ft.)
H1	1X1	6 192	1350	3.50
H2	1/2X1	6 192	1750	3.90
H3	1/2X1	6 192	1750	4.85

Ph: 1.800.223.5873 • Fax: 218.773.0995 • www.mayomfg.com

MasterCard • Visa

Mayo

FASTENERS



ALLIGATOR FASTENERS

MANY SIZES AVAILABLE
CALL FOR MORE INFORMATION & QUOTES

STEEL

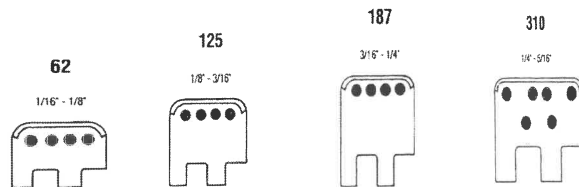

ITEM NO.	PART NO.	SIZE	LENGTH
1505900	125J24NC	125	24
1506200	125J30NC	125	30
1510000	187J24NC	187	24

ALLIGATOR STAPLE

CARTON CONTENTS

- 4 Fastener Sets
- 4 Hinge Pins
- Required amount of staples and retaining washers

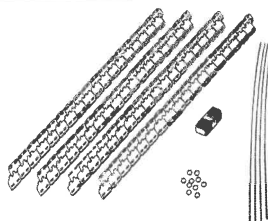

STAINLESS STEEL

ITEM NO.	PART NO.	SIZE	LENGTH
1506500	125SJ24NCS	125	24
1510100	187SJ24NCS	187	24

PIN CONNECTORS

CALL FOR INFORMATION & PRICES!

FASTENER ATTACHMENT KIT

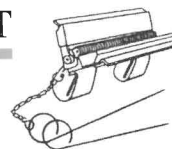

Call for more information and prices!

BOLT ON FLIGHTING

TATCH-A-CLEAT

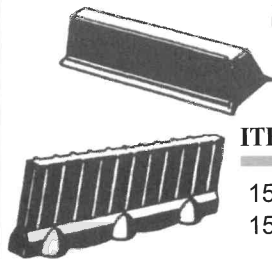

ITEM NO.	PART	HEIGHT	NO.
1501300	I	5/8-b	5/8
1501400	L1-B		1

BELT TOOLS

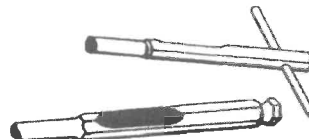

ITEM NO.	PART NO.
1502000	p1p
1502100	p2p
1502200	hp1
1502300	hp2

ECONO-CLEAT

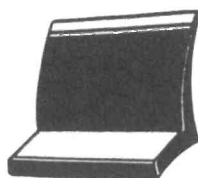

ITEM NO.	PART NO.	HEIGHT
1501000	ec-1-1/4	1-1/4
1501100	ec-2	2
1501200	ec-3	3

BELT ATTACHMENTS



ITEM NO.	PART NO.
1503300	1/4 x 1
1503400	1/4 x 1-1/4
1503700	5/16 x 1

FLEXCO

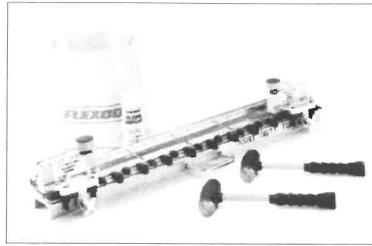

SR INSTALLATIONS TOOLS

Flexco® SR Scalloped Edge Fastener System Selection Guide

Fastener Size	Belt Thickness Range		For Belts with Mechanical Fastener Ratings Up to:		Recommended Minimum Pulley Diameter (Operating Tension 75%-100% of Belt Rating)	
	In.	Mm	P.I.W.	kN/m	In.	mm
R2	1/8 – 3/8	3 – 10	330	60	5	125
R5	7/32 – 7/16	6 – 11	450	79	9	230
R5-1/2	5/16 – 19/32	8 – 15	650	114	12	300
R6	13/32 – 11/16	10.5 - 17	800	140	18	450
RAR6LP	5/16 – 23/32	8 – 18	800	140	18	450

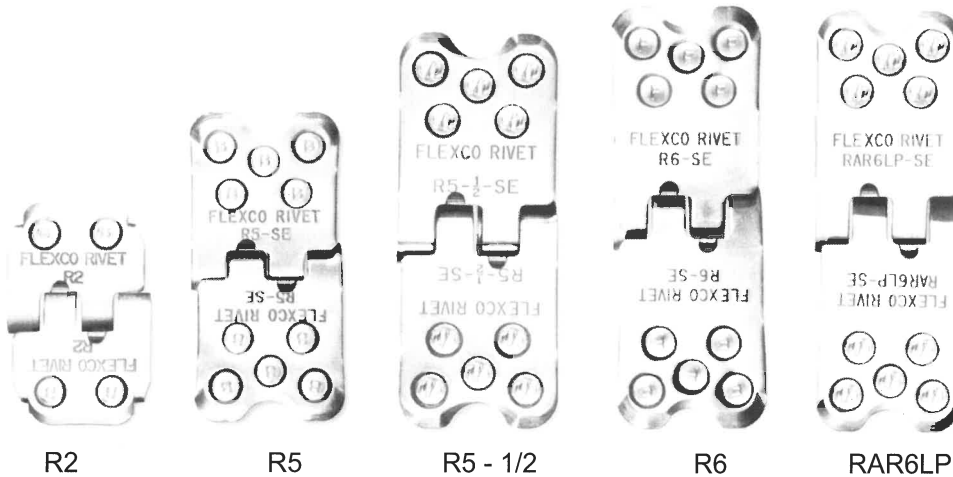

HINGE PINS



RIVETS



CONVEYOR COMPONENTS

Call for Quotes on
Specialty Items!

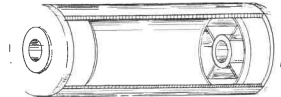

GRADER TUBE ENDCAPS

ITEM NO.	PART NO.	TUBE I.D.	BORE
1532600	R13		1/2
1532700	R14	1 3/8	1/2
1532800	R15	1 1/2	1/2
1532900	R16	1 5/8	1/2
1533100	R20	1 13/16	1/2
1533200	R20	5/8	
1533300	R22	2 1/8	1/2
1533400	R24	3/8	
1533500	R24	2 3/8	9/16
1533510	R24	1/2	
1533600	R26	2 5/8	3/8
1533700	R26	2 5/8	1/2

GRADER PILLOW BLOCKS

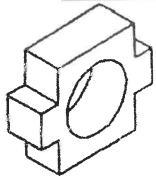

ITEM NO.	PART NO.	O.D.
1376700	BH522	52MM
1376600	BH622	62MM

RUBBER ROLLERS & SPINDLES



ITEM NO.	PART NO.	SPIDLE O.D.	REQ.
1520900	UR3	3 1/2	55680
1521000	UR4	4	55100

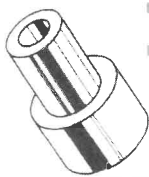

ITEM NO.	PART NO.	TOTAL LENGTH	BORE
1373200	55680	3	1/2
1373550	55100	3 1/4	1/2
1373500	SS100	3	1/2
1373600	SS100M	2.9	1/2

SKATE WHEELS



ITEM NO.	O.D.	BORE	MATERIAL
1533900	2	1/4*	Polyurethane
1534100	2	1/4	Steel

*1534000 Bushing for Polyurethane Wheel

6 POINT STAR ROLLERS

Available In Both
Rubber & Urethan Material

HUB DIAMETER: 2 1/2" OD
HUB WIDTH: 1 1/4"
ROLLER OD: 6 1/4"
FINGER WIDTH: 7/16"
SQUARE BORES: 1 1/4" OR 1 1/2"



ITEM NO.	STAR ROLLER	SQ. BORE	DURO
P612555R	6 POINT	1 1/4"	55
P612570R	6 POINT	1 1/4"	70
P615055R	6 POINT	1 1/2"	55
P615070R	6 POINT	1 1/2"	70

ALL RUBBER CONSTRUCTION

12 POINT STAR ROLLERS

Available In Both
Rubber & Urethan Material

HUB DIAMETER: 2 1/2" OD
HUB WIDTH: 1 1/4"
ROLLER OD: 6 1/2"
FINGER WIDTH: 7/16"
SQUARE BORES: 1 1/4" OR 1 1/2"



ITEM NO.	STAR ROLLER	SQ. BORE	DURO
P12A12555R	12 POINT	1 1/4" SQ BORE	55 ("A")
P12A12570R	12 POINT	1 1/4" SQ BORE	70 ("A")
P12A15055R	12 POINT	1 1/2" SQ BORE	55 ("A")
P12A15070R	12 POINT	1 1/2" SQ BORE	70 ("A")
P12B12555R	12 POINT	1 1/4" SQ BORE	55 ("B")
P12B12570R	12 POINT	1 1/4" SQ BORE	70 ("B")
P12B15055R	12 POINT	1 1/2" SQ BORE	55 ("B")
P12B15070R	12 POINT	1 1/2" SQ BORE	70 ("B")

ALL RUBBER CONSTRUCTION

IDLERS

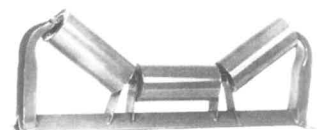

CONVEYOR COMPONENTS

HEAD & TAIL ROLLERS

CALL FOR SIZES
AND QUOTES

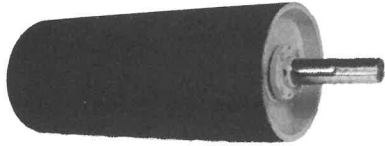

BRUSH ROLLERS

CALL FOR SIZES
AND QUOTES

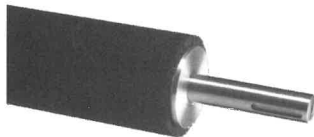

DIAMOND-TOP BELTING



ITEM NO.	WIDTH
2003550	8
2003600	12
2003900	18
2004100	24
2004700	30
2005000	36

ACORN (SIZING/KNOBBY) ROLLERS

Full or Half Size Rollers
All Rubber Construction



ROLLER WIDTH: 3" FULL SIZE
ROLLER OD: 4"
SQUARE BORES: 1 1/4" OR 1 1/2"

ROLLER	SQUARE	BORE	DURO
ARF12540	Acorn Roller	1 1/4"	40 Full Size
ARH12540	Acorn Roller	1 1/4"	40 Half Size
ARF15040	Acorn Roller	1 1/2"	40 Full Size
ARH15040	Acorn Roller	1 1/2"	40 Half Size

6 POINT FINGER ROLLERS

ALL RUBBER CONSTRUCTION

HUB DIAMETER: 2 1/2" OD
HUB WIDTH: SEE BELOW
ROLLER OD: 5 1/4"
FINGER WIDTH: 3/4"
SPECIAL ORDER SQUARE BORE: 1"
STANDARD SQUARE BORES: 1 1/4" OR 1 1/2"



FINGER ROLLER	SQ	BORE	WIDTH	DURO
P610025040	6	1"	2 1/2"	40
P610027540	6	1"	2 3/4"	40
P610030040	6	1"	3"	40
P612525040	6	1 1/4"	2 1/2"	40
P612527540	6	1 1/4"	2 3/4"	40
P612530040	6	1 1/4"	3"	40
P612535040	6	1 1/4"	3 1/2"	40
P615025040	6	1 1/2"	2 1/2"	40
P615027540	6	1 1/2"	2 3/4"	40
P615030040	6	1 1/2"	3'	40
P615035040	6	1 1/2"	3 1/2"	40

Ph: 1.800.223.5873 • Fax: 218.773.0995 • www.mayomfg.com

MasterCard • Visa

Mayo

SUGAR BEET COMPONENTS

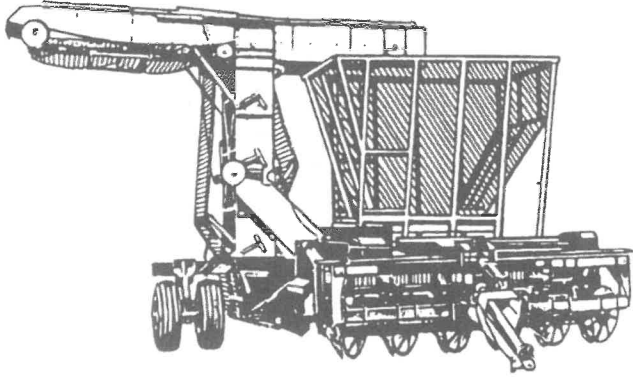

SUGAR BEET SECTION

NOFFSINGER BELTED & HOOK CHAINS



CALL FOR QUOTES
&
MORE INFORMATION!

BELTED CHAIN

HOOK CHAIN

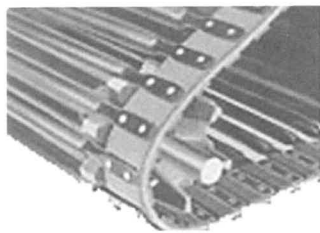
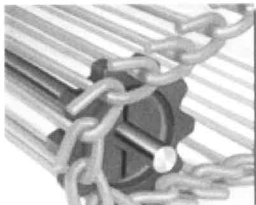

UHMW & HMW BOXLINER PLASTICS

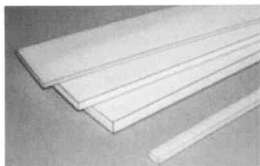

ITEM NO.	WIDTH
063850	1/8"
063855	3/16"
063870	1/4"

Mayo can get any size
of UHMW!
Call for more
Information
& prices!

BLACK ACE ROLLER & SPROCKETS



Full Line Supplier of Black Ace Parts.
Call for quantity of prices.

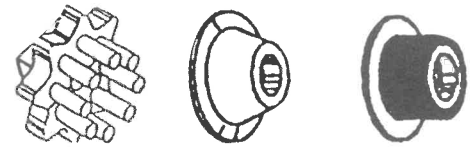

CHAIN TOOLS & TIGHTENERS

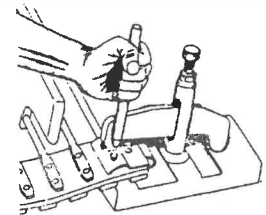

PATENT PENDING

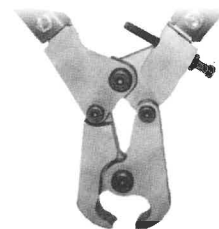

Mayo

Ph: 1.800.223.5873 • Fax: 218.773.0995 • www.mayomfg.com

MasterCard • Visa

SUGAR BEET COMPONENTS

MAYO CARRIES ALL YOUR SUGAR BEET REPLACEMENT PARTS



NOFFSINGER BEEET FLAILS

- Straight & Tapered
- Durable Hard Rubber
- Call for Prices



Browning

- American Made
- Call for Quotes

BROWING SPROCKETS, PULLEYS, INSERTS, BELTS & ROLLER CHAIN



AG PARTS - R & K INDUSTRIAL WHEELS

R & K ROLLERS



CARRIER ROLLERS



ROLLER & WHEEL COMPONENTS

- American Made
- Full Line Stock Available
- Call for Prices

snapidle
chain & belt tensioners

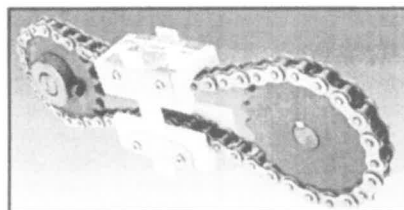

SNAPIDLE TENSION TIGHTENER

- Durable High Impact UHMW
- Long - Life, Low Noise
- Call for Prices

Ph: 1.800.223.5873 • Fax: 218.773.0995 • www.mayomfg.com

MasterCard • Visa

Mayo

ROLLER COMPONENTS



We stock a full line of Black Ace components. Call for information or a catalog.

ROLLER COMPONENTS

STEEL CONE ROLLERS

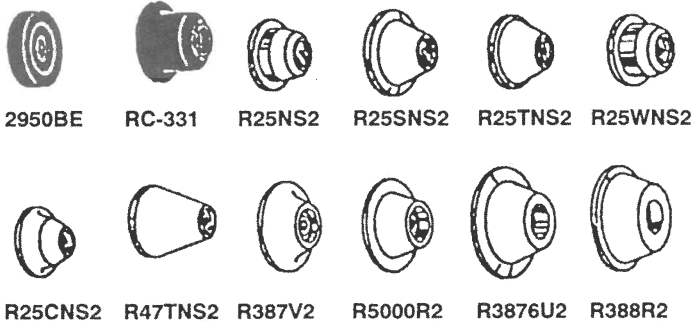

FLANGE STEEL ROLLERS

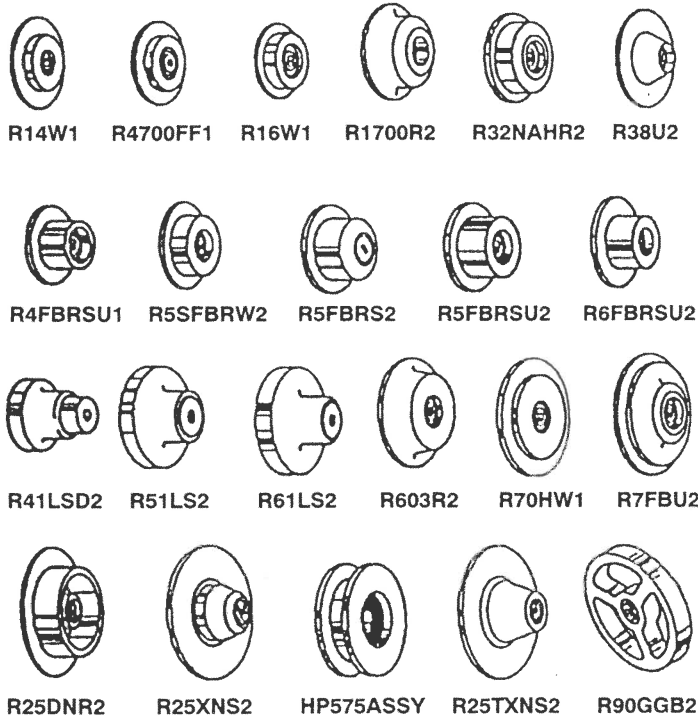

SPLIT STEEL SPROCKETS

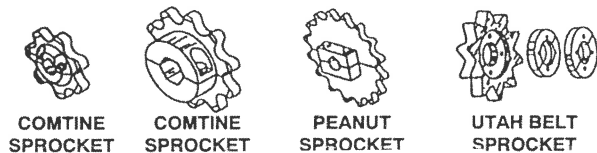

SCRAPERS



IDLER TIGHTENERS



RUBBER ROLLERS

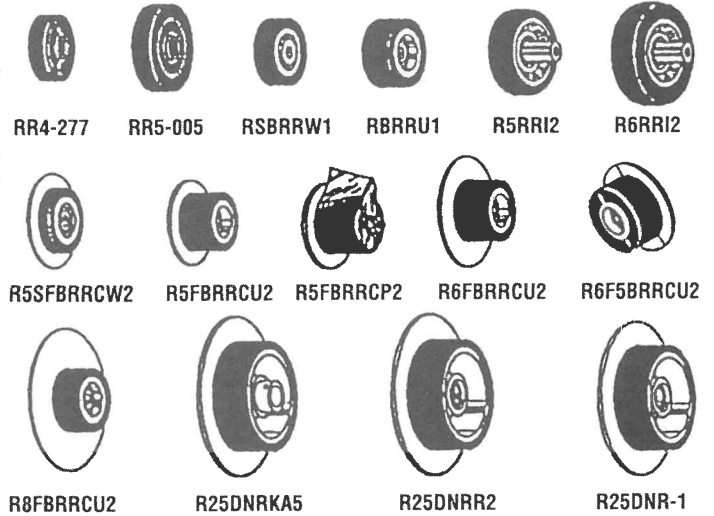

STEEL IDLER ROLLERS

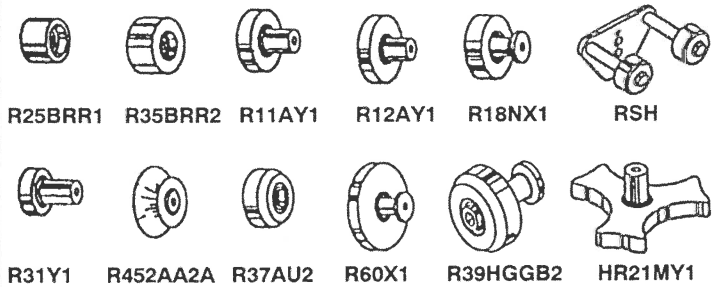

ROD CHAIN SHAKERS

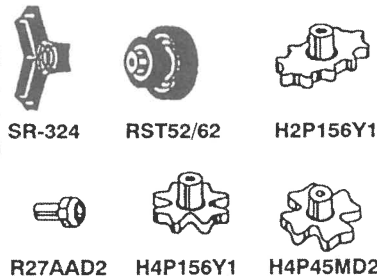

BEARING HOLDERS

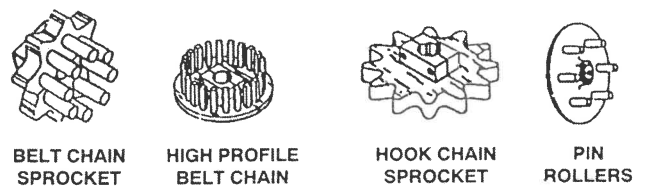
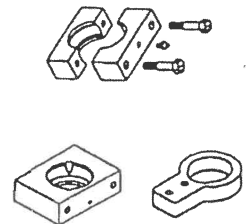

CONVEYOR CHAIN



CONVEYOR CHAIN



HOOK CHAIN

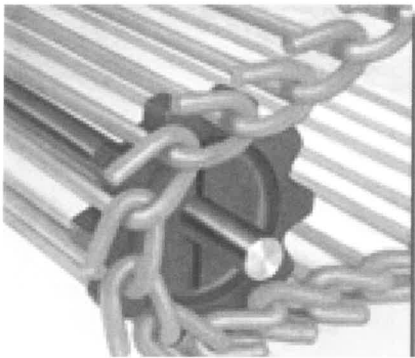

SIZING SCREEN

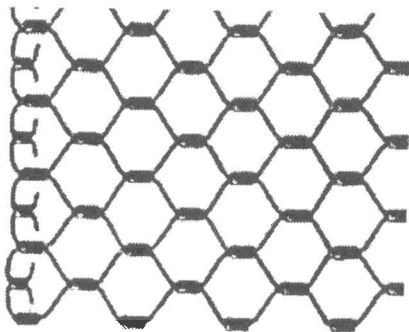

SCREEN CONNECTORS

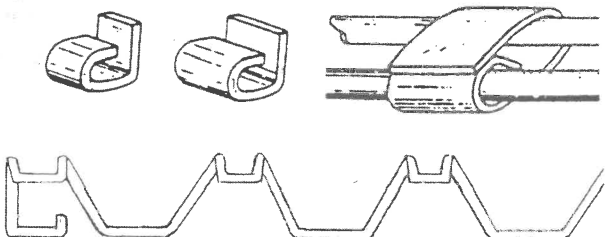

BELTED CHAIN

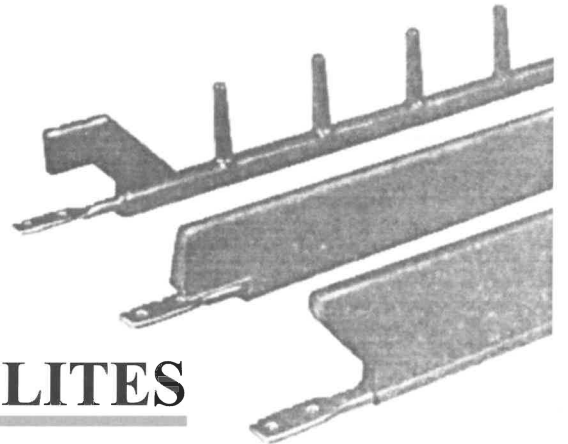
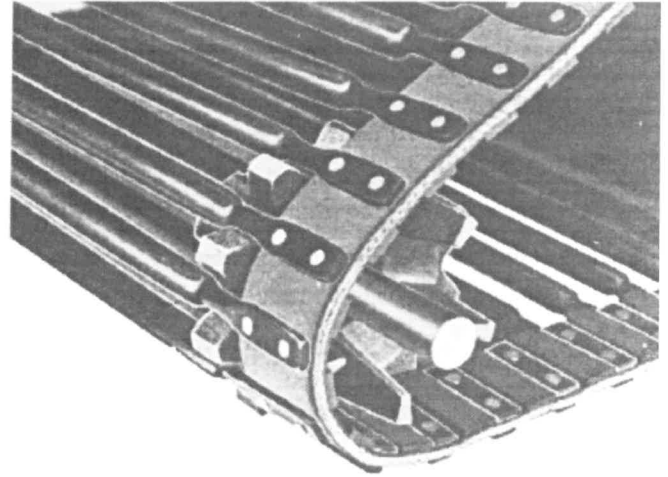

FLITES

BELT CLIPS



CLIP RODS



Ph: 1.800.223.5873 • Fax: 218.773.0995 • www.mayomfg.com

MasterCard • Visa

Mayo

LUBRICANTS & PAINT

LPS LUBRICANTS AND PENETRANTS

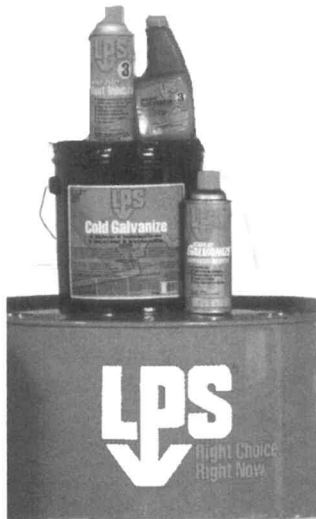

ITEM NO.	PART NO.	LPS PRODUCT	QTY.
1435100	01128	LPS-1 Greaseless Lubricant	1 gal.
1435300	0016	LPS-1 Greaseless Lubricant	11 oz.
1435400	02128	LPS-2 Industrial Strength Lube	1 gal.
1435500	00216	LPS-2 Industrial Strength Lube	11 oz.
1435700	00255	LPS-2 Industrial Strength Lube	55 gal.
1435800	03128	LPS-3 Heavy-Duty Rust Inhibitor	1 gal.
1435900	00316	LPS-3 Heavey-Duty Rust INhibiter	11 oz.
1436000	00516	LPS-Cold Galvanize	16 oz.
1436100	00720	LPS Instant Super Cleaner/Degreaser	20 oz.
1436300	03228	LPS Super 140 Cleaner/Degreaser	1 gal.
1436400	40320	LPS Dujal Action #1 Gold	16 oz.
1436500	40120	LPS Dual Action Plus #1	16 oz.
1436700	0216	LLPS Dual Action Aquacut	16 oz.
1436800	01228	LPS Dual Action Aquacut	1 gal.
1437000	60155	LPS Rapid Strong Steel Renewal	5 oz.
1437200	02416	LPS Chain Mate	11 oz.
1437300	02516	LPS Force 842	11 oz.
1437400	02616	LPS Open Gear Lube	11 oz.
1437500	02728	LPS Precision Clean	28 oz.
1437600	01516	LPS Heavy-Duty Silicone Lube	13 oz.
1438400	00616	LPS Magnum Lubricant	11 oz.
1438700	03116	LPS CFC Free Electro Contact Cleaner	11 oz.
1439000	0916	LPS Torque LST Penetrant	11 oz.

AEROSOL PAINTS



CALL FOR PRICE AND
OTHER COLORS!

12 Oz. Cans

ITEM NO.	PART NO.	COLOR
1440000	5FW98	Machine Gray
1440300	6MT27	Gray Primer
1437480	5FX12	Gloss Green
1440800	1VAK2	Gloss White
1440900	6004	Bright White
1437450	6KP14	Red Oxide Prime
1441300	1VKAZ	Gloss Black
1441800	61003	Yellow
1442400	6MT50	Blue Gray
1437475	6MT41	Ford Blue
1439800	6261	IH Red
1442900	6MT52	Flat Black
1439600	6750	Mayo Orange
1442000	5FW97	Chrome Silver

Mayo APPROVES
Mobil PRODUCTS

FOR PRODUCT CAMPATABILITY
CALL 1.800.662.4525

ITEM NO.	DESCRIPTION
1445025	#32 ISO FOOD GRADE HYD. FLUID
1445020	*MOBIL GLYGOYLE 460 FOOD GRADE
1456065	*MOBIL SHC 630 REDUCER GEAR OIL
1456060	MOBIL 75W-90 WHEEL DR GEAR LUB
1456200	1MUC1 TUBE GREASE MOBIL AW2 MP FM222 FOOD GRADE GREASE

* REDUCER OIL

Mayo

Ph: 1.800.223.5873 • Fax: 218.773.0995 • www.mayomfg.com

MasterCard • Visa

ELECTRICAL COMPONENTS



CONTROL PANELS

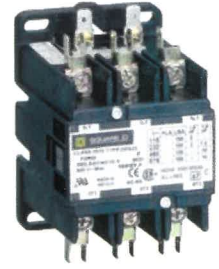

SPEED CONTROLS

MOTORS & GEARDRIVES



REMOTE CONTROLS



CORD ENDS & ACCESSORIES

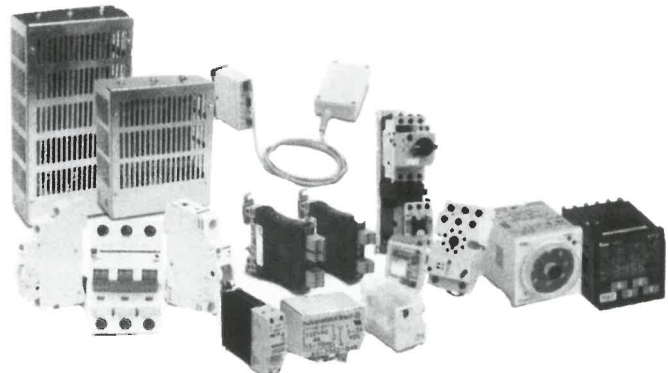

Ph: 1.800.223.5873 • Fax: 218.773.0995 • www.mayomfg.com

MasterCard • Visa

Mayo